

## Individual wastewater solutions for up to 5,000 PE / 750 m<sup>3</sup> per day

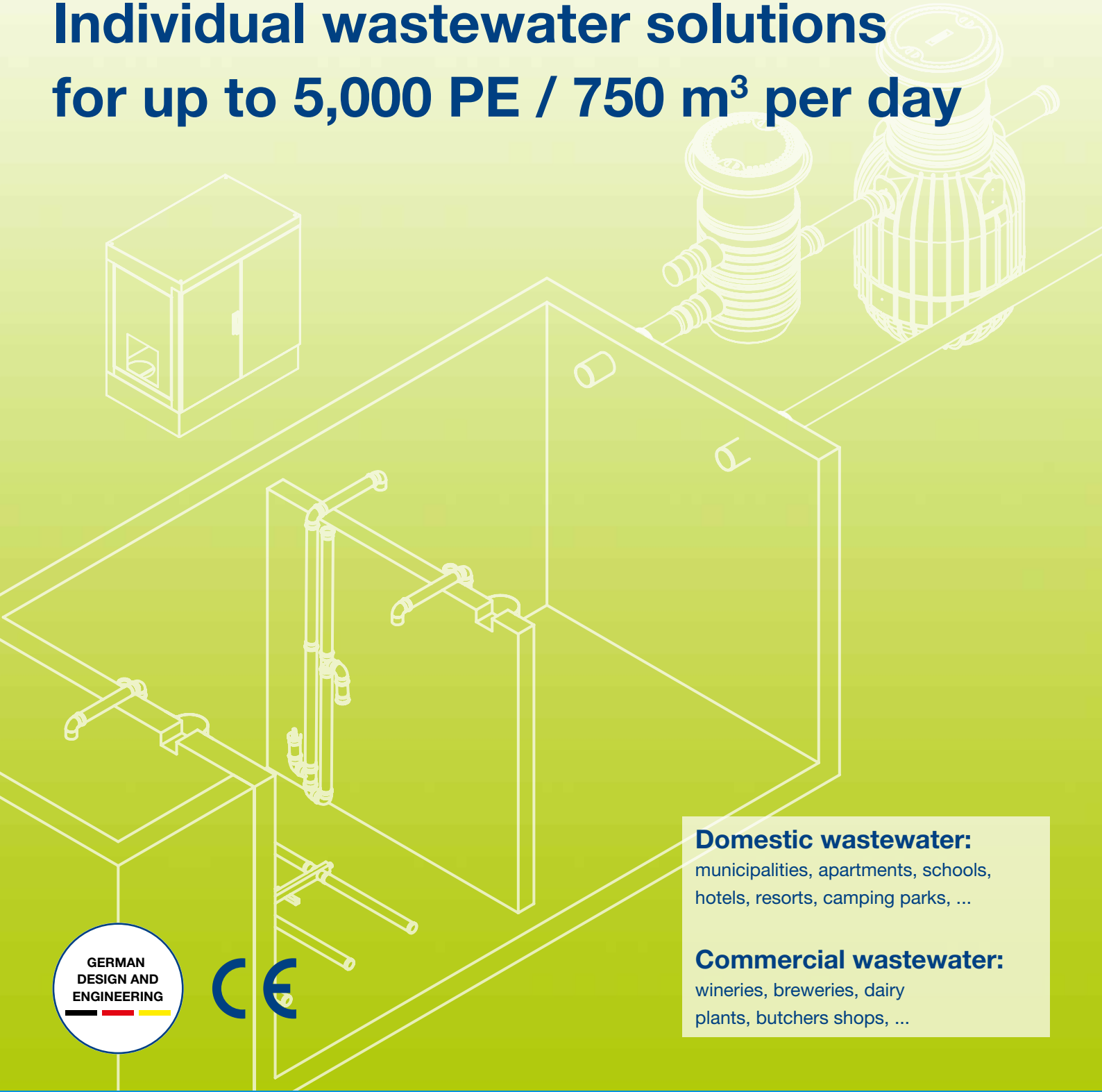

### Domestic wastewater:

municipalities, apartments, schools,  
hotels, resorts, camping parks, ...

### Commercial wastewater:

wineries, breweries, dairy  
plants, butchers shops, ...

GERMAN  
DESIGN AND  
ENGINEERING



No mechanical parts  
in the wastewater



No pumps  
in the wastewater



No electrical parts  
in the wastewater



## KLARO stands for

### Quality



Development and design of the high-quality products in Germany.

### Security



No mechanical systems, no pumps and no electrical systems in the waste water.

### Innovation



Awarded the seal of approval for “innovation through research”.

### Fast production



Standard systems are ready for shipping within 24 hours.



## INDIVIDUAL WASTE-WATER SOLUTIONS ALL OVER THE WORLD

More than 500,000 people in more than 70 countries derive benefit from the sophisticated KLARO treatment technology.

### Flexibility



Our systems are flexible, easily adjustable and expandable.

### Service



Fast, competent and technical support.

### Technology



We always use state-of-the-art technology.

### Eco. friendliness



Environmentally friendly by virtue of being a fully-biological clarification process.



<b>KLARO GmbH in Bayreuth</b>	<b>06</b>
Experience and expertise in wastewater treatment plants	06
A team of specialists	07
<b>Process</b>	<b>08</b>
KLARO system	10
Process description	10
KLARO SBR cycle	11
KLARO One system	12
Process description	12
KLARO One SBR cycle	13
KLARO MAX system	14
KLARO principles	18
Separation of wastewater and technology	18
Independent of tank geometry and material	19
Tank arrangements	20
Commercial wastewater	22



Breweries	23
Dairy plants	24
Wineries	25
<b>Components</b>	<b>26</b>
Components of a sewage plant	28
Switch cabinet types	30
Alternative to switch cabinet	31
Mounted parts in the switch cabinet	32
Control cabinet	34
Controllers	36
Compressor	37
Expansions	40
Flow chart of a sewage plant	42
<b>Planning and service</b>	<b>44</b>
Project flow	46
Plant design	48
<b>References</b>	<b>50</b>



KLARO company premises in Bayreuth

## More than 15 years of experience and expertise in sewage plants!

KLARO has been taking care of your clear water needs since 2001. Wherever a connection to the sewage system is economically not feasible, our services come in useful. Whether a single-family detached house, hotel or municipality – KLARO has the right sewage system for each application, for 0,6 up to 750 m<sup>3</sup>/d. Our long-standing project experience, combined with numerous upgrade options, allow us to customise our systems optimally to your individual situation.

\* m<sup>3</sup>/d = cubic meter per day  
m<sup>3</sup>/d = KLD  
1 m<sup>3</sup>/d = ~ 7 PE

### Research and development

In the test plants, the KLARO development team tests new components under real conditions and over a long period of time. Not only does the team develop existing systems further here, but also creates completely new concepts.

Furthermore, the test facility is used as a demonstration site for visitors to explain the KLARO process to them.



Test plants in Bayreuth



KLARO Team

## A team of specialists

- ✓ **One-on-one consulting sessions can be arranged quickly and without any hassles**
- ✓ **Support and clarification provided if technical questions and issues arise**
- ✓ **Long-standing experience of our engineers**
- ✓ **Centre of excellence in the field of wastewater and separation technology of the entire Graf Group**



**For expert advice:**  
+49 (0)921 16279 370



[www.klaro.eu](http://www.klaro.eu)  
[info@klaro.eu](mailto:info@klaro.eu)

## A company of the GRAF group

Since 2014, KLARO has been part of the globally operational GRAF group. The GRAF brand has been synonymous with high-quality plastic products in the field of water resource management for more than 50 years.

GRAF is well-known to KLARO as a long-standing customer and supplier of water sewage tanks made of plastic. Thus, when you buy a KLARO product, you benefit from the know-how and quality of two established brands in the field of local wastewater disposal.



GRAF plant in Teningen near Freiburg





The word "PROCESS" is written in a large, white, sans-serif font, centered in the lower right portion of the page. It is positioned above a white horizontal line that spans the width of the table below.

KLARO system	10
KLARO <i>One</i> system	12
KLARO MAX system	14
KLARO principles	18
Tank arrangements	20
Commercial wastewater	22

## Process description

Fully-biological wastewater treatment plant using the SBR process (= activated sludge system in more chamber tank with sequencing batch reactor) with upstream sludge storage and buffer tank.

### Structure - Two-stage SBR process

#### 1. Stage/chamber:

##### sludge storage tank and buffer tank

- storage of primary and secondary sludge
- retention of settling solids and floating substances
- storage of inflow water
- balancing of volume and concentration related fluctuations in the waste water inflow.

#### 2. Stage/chamber: activated sludge stage operated in single, closed reactor in sequenced batch mode (= Sequencing batch reactor)

- biological clarification with activated sludge
- nitrification and denitrification
- phosphate precipitation (optional)

**Further clarification steps can be added downstream (see page 38).**

### Operating mode

- Real-time control via microprocessor with ex-factory process flow settings
- Standard setting: 4 clarification cycles of 6 hours each per day
- Alternatively, fill-level dependent operating mode can be selected; the fill level is then measured by a pressure sensor integrated in the controller
- Process flows can be changed by competent personnel
- Waste water aeration via membrane diffuser in the tank floor
- Use of air lifter for transport of wastewater/clear water/waste sludge

### Process flow quality

- Comparable with large, municipal clarification plants
- Dimensioning and selection of the clarification stages can be customised to suit your requirements

### Advantages

- Very stable process as compared to hydraulic shock loads and underload
- High operational reliability and low maintenance expenditure
- User-friendly due to automatic operating mode
- Low energy consumption due to micro-bubble aeration
- Low disposal costs, since only the sludge tank and not the complete plant must be emptied periodically
- Stable clarification performance even in winter
- Independent of tank material and geometry
- Various options for adjusting the process via the controller
- Safe, sturdy and long-life product due to the KLARO principle (see page 18)
- Sophisticated technology – market launch in 2001

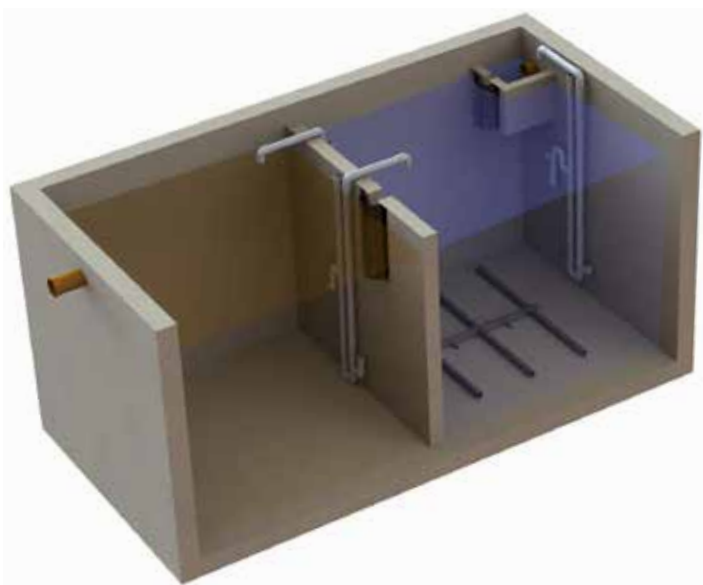

## KLARO SBR cycle

### 1. Loading phase

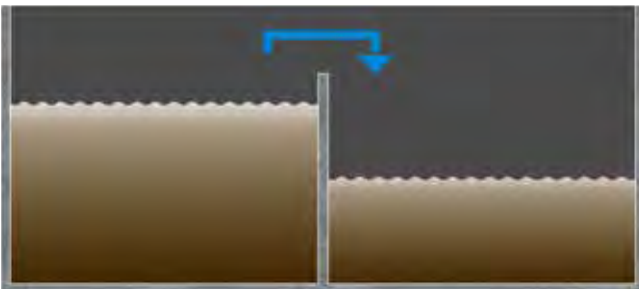

The raw wastewater temporarily stored in the sludge storage/ buffer tank is supplied to the SBR via an air lifter. The air lifter is positioned so that only solid-free water is pumped out. The special design of the lifter ensures a minimum water level in the sludge storage tank. Limiting the water level by incorporating other components (e.g., a float switch) is therefore not required.

### 2. Aeration phase

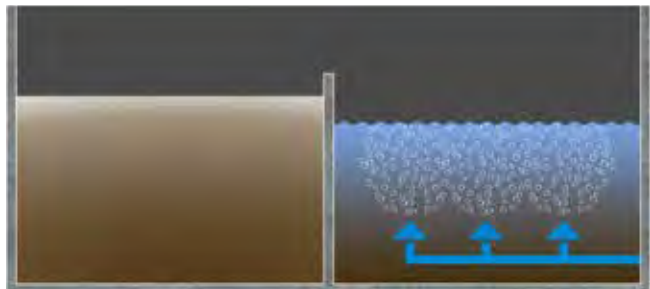

The wastewater is aerated and mixed with fine-bubble diffusers fixed to the floor of the tank. The compressed air required for that is produced by an air compressor located in an external control cabinet. Aeration generally takes place intermittently. Two effects are achieved simultaneously by this aeration:

- the microorganisms in the activated sludge are supplied with oxygen, which is necessary for their metabolic activity and thereby for the reduction of pollutants
- it brings the bacteria in close contact with the wastewater.

### 3. Settle phase



No aeration takes place during the 90 minute settling phase. The activated sludge is allowed to settle. A sludge blanket forms on the tank floor and in the upper region of a clear water zone.

### 4. Clear water extraction and sludge return

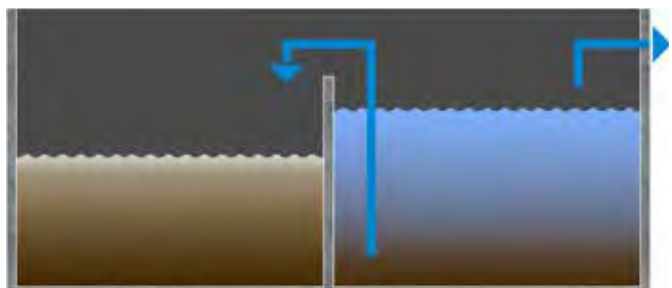

The clear water is pumped out from the SBR stage using air lifter. The special design of this air lifter

- incorporates an air barrier that minimises the undesired penetration of activated sludge into the lifter during the aeration phase (see page 28)
- ensures that a minimum (desired) water level is maintained in the plant without any need for additional components

Excess sludge is returned to the sludge storage tank via the air lifter.

## Process description

Fully biological wastewater treatment plant using the SBR method (= sequencing batch reactor with activated sludge) with simultaneous aerobic sludge stabilisation. Sludge storage and buffer tank are integrated.

### Structure - Single-stage SBR process

The septic tank is divided into two zones by an underflow baffle.

The underflow baffle retains large debris in the primary zone and prevents short-circuiting of flow up the walls.

#### Both zones:

- aeration, aerobic conditions, biological clarification with activated sludge
- nitrification and denitrification
- storage of inflow water
- storage of secondary sludge
- phosphate precipitation (optional)
- sludge stabilisation is achieved by low volumetric loading, prolonged sludge ageing and intensive aeration

**Further clarification steps can be added downstream (see page 38).**

### Operating mode

- Real-time control via microprocessor with ex-factory process flow settings
- Standard setting: 2 clarification cycles of 12 hours each per day
- Alternatively, fill-level dependent operating mode can be selected; the fill level is then measured by a pressure sensor integrated in the controller
- Process flows can be changed by competent personnel
- Waste water aeration via membrane diffuser in the tank floor
- All pumping operations via air lifter

### Process flow quality

- Comparable with large, municipal clarification plants
- Especially effective reduction of nutrients (N and P)
- Dimensioning and selection of the clarification stages can be customised to suit your requirements

### Advantages

In addition to the aforementioned advantages – safe, effective, flexible, long service life – the KLARO SBR cycle also has the following advantages:

- No need for a thick partition wall
- No anaerobic processes, no putrid smell, no risk of concrete corrosion
- Very little sludge generation, no digested sludge, sludge treatment on site possible (see page 40)
- Especially easy maintenance, no need for sludge measurement in primary clarification stage
- Tried and tested technology – has been used a thousand times over since its market launch in 2015

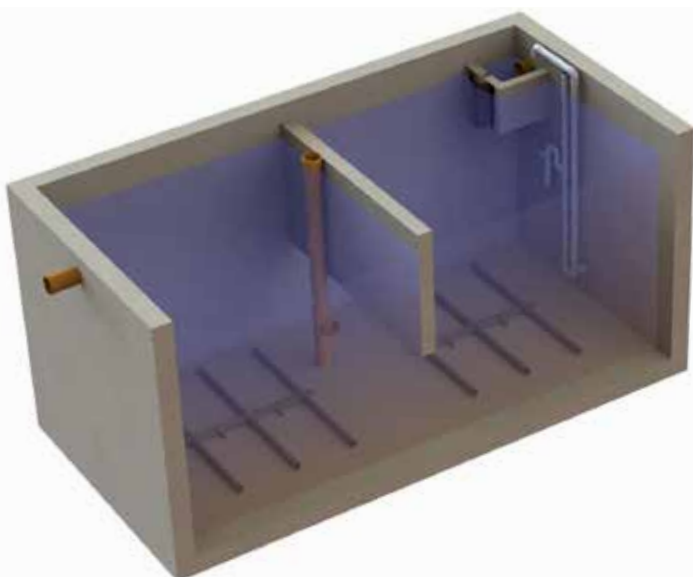

## The KLARO One SBR cycle

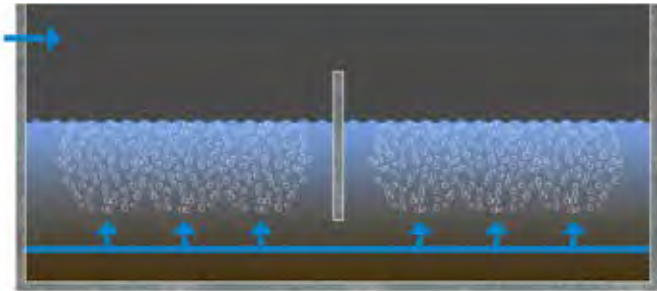

### 1. Aeration phase

The raw wastewater initially reaches the primary zone of the plant and directly undergoes aerobic treatment. Membrane diffusers on the tank floor ensure that there is sufficient aeration of the entire tank volume. The compressed air required for that is produced by an air compressor located in an external control cabinet. Aeration generally takes place intermittently. This aeration has the following effect:

- The microorganisms of the activated sludge are supplied with oxygen, which is necessary for their metabolic activity and thereby for the reduction of pollutants. The bacteria comes in intensive contact with the food source in the wastewater.
- Mineralisation of the sludge

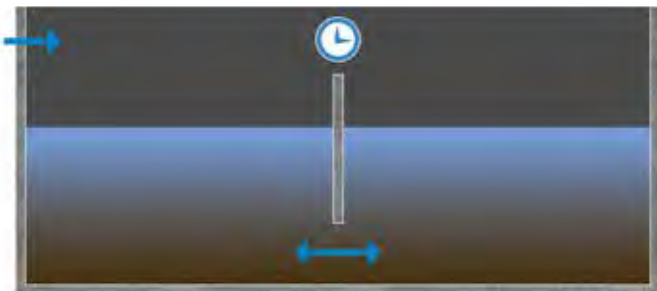

### 2. Settle phase

No aeration takes place during the 120 minute settling phase. The activated sludge is allowed to settle. A sludge blanket forms on the tank floor and in the upper region of a clear water zone. Inflowing raw waste water is retained in the primary zone.

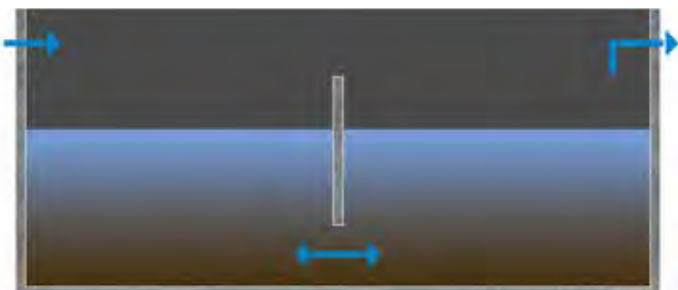

### 3. Clear water extraction

An air lifter in the rear area of the plant pumps out a part of the clarified water from the tank. The special design of this air lifter

- prevents any floating surface sludge from being drawn off along with the clarified water
- incorporates an inflow baffle that minimises the undesired penetration of activated sludge into the air lifter during the aeration phase
- ensures that a minimum (desired) water level is maintained in the plant without any need for additional components

## Process description

SBR technology is proving to be an optimal process for treating wastewater in small sewage treatment plants. The strict separation of the process phases results in a variety of control options for the purification process. This in turn allows for economic construction, operation and powerful purification capacity of the plants.

For these reasons, we have implemented SBR technology for wastewater treatment plants beyond our standard sizes (up to 1,500 PE / 225 m<sup>3</sup> per day) and extended its use to plants up to a connection size of 5,000 PE / 750 m<sup>3</sup> per day.

## Plant concept

The procedural concept includes the technical dimensioning with individual design of the wastewater treatment plant components. Depending on requirements and local conditions, this includes mechanical pre-treatment, pumping stations, pre-storage, biological treatment stage(s), sludge storage and treatment, and reuse of treated wastewater.



Essentially, the concept provides two variants:

### 1. Single-train SBR plants ...

... with upstream storage tank (pre-storage)

Range: Up to 3,000 PE / 450 m<sup>3</sup> per day

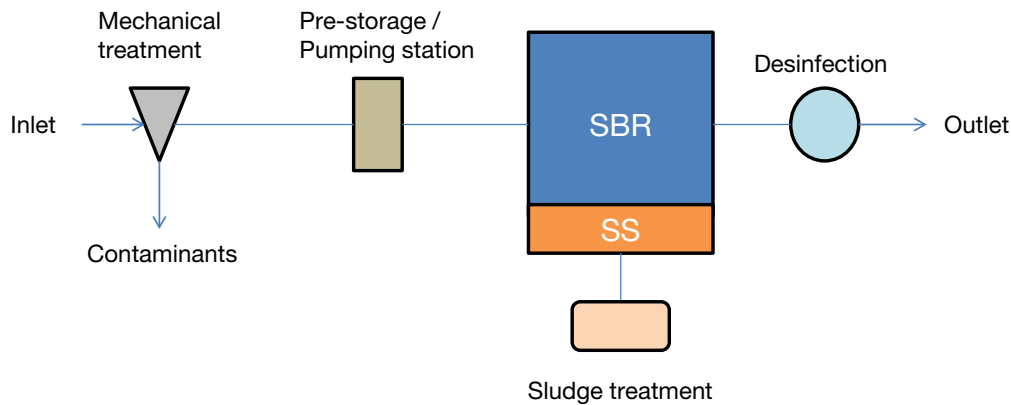

Figure 1: Flow diagram of a single-train SBR plant with pre-storage

The single-train SBR plants are always implemented with pre-storage so that no untreated wastewater flows into the SBR basin during clear water withdrawal. Only one SBR basin is required for these plants. The pre-storage allows for volume and concentration equalisation, decouples the inflow from the cycles in the SBR basin, and ensures short-term supply.

### 2. Double-train SBR plants ...

... without pre-storage.

Range: Up to 5,000 PE / 750 m<sup>3</sup> per day

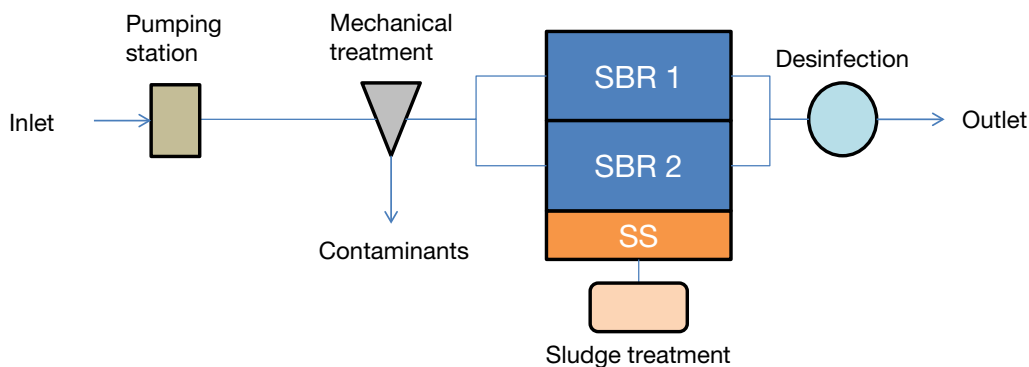

Figure 2: Flow diagram of a double-train SBR plant without pre-storage

The two-train SBR plants are usually implemented without pre-storage. The inflowing wastewater is first fed into the first SBR basin, and then into the second SBR basin. As a result, return contamination of the purified clear water is prevented by inflowing wastewater, even without pre-storage.

# KLARO MAX system up to 5,000 PE / 750 m<sup>3</sup> per day

## Control process

The control process is the core of a modern SBR plant. The control process used for managing the cycle and for controlling the individual components works on demand and is freely configurable. The measuring equipment further ensures the optimisation and flexibility of the operating parameters and can be designed to meet the respective requirements.

## Pre-storage

The pre-storage is built in the bypass arrangement. The inflowing wastewater first enters the pre-storage as soon as the inlet opening of the SBR basin is closed. This reduces the volume to a minimum. The pre-storage contains pumps that pump the stored wastewater directly into the SBR basin.

## Aeration/circulation

The aeration of the SBR basins is achieved with the help of air. Membrane aeration devices attached to the basin floor are supplied with air from a pressure line via blowers. These facilities are designed so that additional circulation units are redundant.

## Sludge treatment

In the sludge treatment, the resulting pre-thickened excess sludge from the sludge tank is subjected to further dilution. As a result, the amount of sludge can be reduced to one tenth of the initial amount. This allows the sludge to be transported economically even over longer distances.

## Mechanical treatment

For wastewater treatment plants of this size, it is expedient to install a device for mechanical wastewater treatment in order to prevent the ingress of coarse contaminants into the SBR basins.

In the mechanical treatment, coarse components of the inflowing wastewater are screened out by a sieve screw. The so-called screenings are conveyed into a waste container.

## SBR basin

One of the biggest advantages of SBR technology is that it is independent of the vessel geometry. The SBR basins can therefore have any desired construction shapes. Damping heights up to 6 m are possible.

## Clear water extractor

Permanently installed decanting units are used for outflow control. The rigid clear water extractors used are very economical outflow controls by design since power is required only for opening and closing. Despite the very simple design of the outflow control, sludge drifting is sufficiently avoided. The extraction devices are structurally designed to allow for maintenance even with filled basins. In addition, the devices have the advantage that they are equipped with motors that allow for continuous adjustment of the openings.

## Disinfection

Disinfection takes place in a contact basin downstream of the aerobic treatment via the metered addition of chlorine or by built-in UV modules.





1.225 PE treatment plant, Ungarn

## Your advantages

- Safe and efficient operation
- Economic construction and operation
- Individual and flexible design
- Modular system components
- Modular building technologies
- Expandable technologies
- Automation of the individual module systems
- KLARO know-how since 2001



Mistelbach, Germany



## Separation of wastewater and technology

### KLARO principle:



No mechanical parts  
in the wastewater



No pumps  
in the wastewater



No electrical parts  
in the wastewater

In the sewage tank, we only use simple, sturdy components and no pumps or other electric parts are used. Nor do we use support media for biological treatment.

All lifters and aeration devices (see page 28) of the KLARO system are driven by compressed air.

The electrical parts are located externally in a switch cabinet. In this way, they are well protected and do not come in contact with the wastewater.

Our technology is thus safe, maintenance-friendly and has long service life. The system excels with its high quality standard, thanks to first class technology and materials on the one hand, and omission of potentially problematic components on the other hand.



## Independent of tank geometry and material

KLARO technology is largely independent of geometry and material of the clarification tank. The volume can be distributed over single or multiple tanks or chambers. These tanks/chambers can be round or rectangular. The only decisive factor is that certain minimum volumes and fill levels must be maintained.

Many plants are still constructed in the classic concrete tank design. However, tanks made of plastic are becoming increasingly popular even in large clarification plants and are steadily gaining ground. In this field, KLARO can draw on a large portfolio of first class plastic tanks manufactured by the GRAF group. For large-sized clarification plants, the tank types Carat 6,500 l, Carat XL 8,500 l, XL10,000 l and XXL16,000 l to 102,000 l come into question.

We provide independent and project-specific advice on advantages and disadvantages – the decision is up to the customer.



# Tank arrangements

## Plant concepts

According to the requirements or structural engineering conditions, the KLARO sewage technology can be accommodated within various tank arrangements.

### New plant

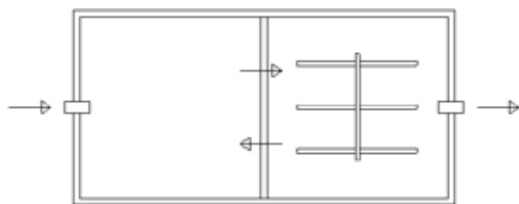

KLARO offers complete sewage treatment plants in prefabricated tanks, which can be delivered pre-assembled to the construction site. (see page 54)

### Expansion

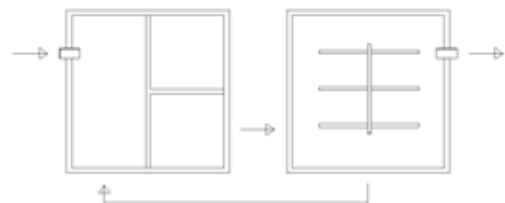

Existing clarification tanks can also be incorporated in the new concept, if their holding capacity is not sufficient for the entire plant. In that case, new tanks can be added downstream of the old tank. The existing tanks are mostly used as sludge storage/buffer tanks and the new ones are used as SBR's, since they can be delivered immediately in practical, pre-assembled condition. (see page 70)

### Additional buffer tank

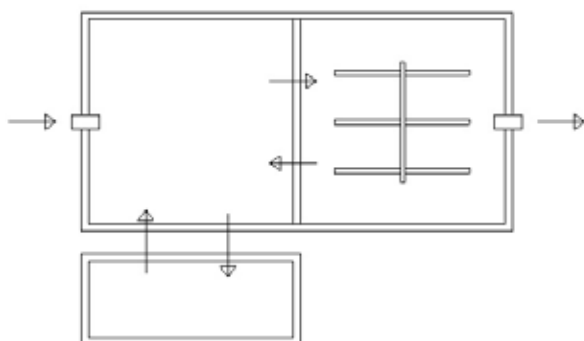

When designing a clarification plant, the maximum daily wastewater generation must generally be taken as a basis, even if this only occurs on a few days (e.g. restaurants on weekends). This results in such clarification plants being relatively large-sized and not being filled to capacity most of the time. We recommend an additional buffer tank to intercept such peak loads. In overload situations, it fills up automatically with mechanically pre-treated wastewater from the primary chamber. The storage tank is then automatically processed later once the required capacities are once again available. (see page 68)

**Advantages:** Peak loads are equalised; the biological stage can be dimensioned to make it smaller.

**Fields of application:** primarily gastronomy, e.g. popular restaurant destinations.

## Retrofit/conversion

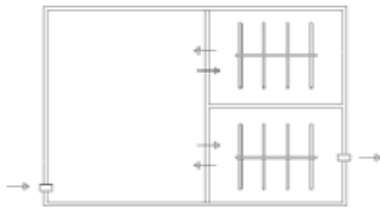

Conversion of existing septic tanks is also possible if holding capacity and basic fabric are in okay condition. KLARO technology is essentially well suited even for renovation and conversion of old plants using other processes. (see page 58)

## Multiple line

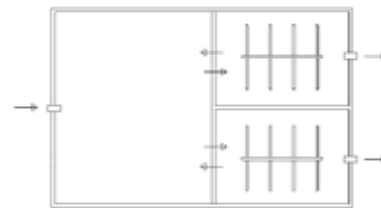

KLARO plants can be expanded subsequently and more lines can be added. In such projects, we plan a central sludge storage/buffer tank which absorbs the complete inflow. From there, the wastewater is distributed over the other sludge storage/buffer tanks via underwater connections. The raw water with its solids can thus be distributed uniformly over the various lines/expansion levels in the easiest possible way. (see page 74)

**Fields of application:** e.g. site development of a residential area, holiday village, hotel, camping park

## Expansion levels

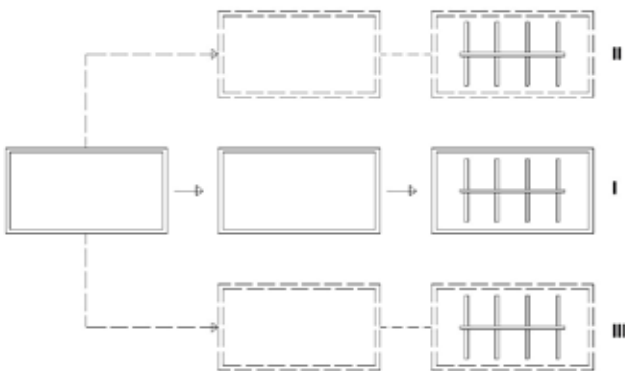

A multiple line plant concept comes into consideration if there are strong seasonal fluctuations. The inflow is directed into a common sludge storage/buffer tank, followed by two or more independent downstream SBR reactors (lines). The lines can be equal in size or can vary. They are operated independent of each other via separate controllers. In off-season, one lane can run in economy mode or stopped completely. (see page 66)

**Advantages:** demand-oriented, economical operating mode

**Fields of application:** primarily gastronomy, e.g. hotels, camping parks.

# Commercial wastewater



## Commercial wastewater

Commercial wastewater is generated during production and processing in industrial and commercial plants. For the most part, it consists of flushing water that is generated during cleaning work. Sometimes, it also consists of domestic wastewater from sanitary facilities or residential houses. In general, such waste waters can have varied compositions depending upon the branch of industry. The inflow volumes, loads and concentrations as well as the pH-values are mostly subject to strong fluctuations. The presence of cleaning agents and disinfectants also has a disturbing effect.

A biological treatment plant process is considered primarily in the case of wastewaters generated in the food production industry. Generally, the KLARO SBR technology is very well suited to such applications thanks to its flexibility and sturdy design. However, each project must be considered individually.

In the following pages (page 23-25), we will describe our wastewater solutions for application in breweries, dairy plants and wineries.

The complete dimension sheets for commercial wastewater can be requested from KLARO.

We will be equally pleased to advise you on other commercial wastewaters that are not listed here.

## Breweries

The commercial wastewater from breweries mostly stems from cleaning of production plants and can contain large debris, such as shards, labels, brewer grains and crown caps.

Over the week, strong fluctuations in wastewater volumes and loads as well as pH-values can occur.

In general, the wastewater has higher pollutant concentrations (BOD<sub>5</sub> values up to 4,000 mg/l), in comparison to domestic wastewater and it is considered to be easily biodegradable due to its favourable COD/BOD ratio.



## Process concept

Since diverse large debris and grit could be present in the wastewater, breweries must include a preliminary treatment tank in their wastewater treatment plant. This fulfils the following functions:

- retention of large debris and equalisation of fluctuating inflow values
- storage of inflow water
- sludge storage

This is followed by clarification using the KLARO SBR process.

## Example of plant

Example of a plant for up to 9 m<sup>3</sup>/d for a brewery with a beer output of 1,000 hl\*/beer per year:

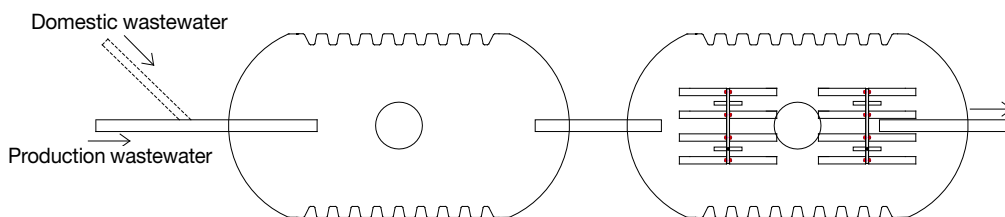

A dimension sheet for the design can be requested from KLARO.

\* hl = hecto liter

# Commercial wastewater

## Dairy plants

The commercial wastewater of dairy plants stems from cleaning of production plants. Mostly, this is “white” water from milk production or “white” water with whey from cheese production.

Many production areas demonstrate equally high proportions of lipophilic compounds (grease) and P-loads. Basically, the inflow concentrations are higher than in domestic wastewater (BOD<sub>5</sub> values up to 3,000 mg/l).

A good COD/BOD ratio is advantageous for biodegradability.



Reference project for 3,75 m<sup>3</sup>/d, dairy farm with holiday homes on page 48.

## Process concept

In order to prevent inhibition of biodegradation due to the presence of too many lipophilic compounds, a KLARO grease separator should be installed upstream of the treatment plant (see page 43). This is additionally used for pH-neutralisation.

Further preliminary clarification steps fulfil the following functions:

- equalisation of fluctuating inflow values
- storage of inflow water
- sludge storage

## Example of plant

Example of plant for up to 2,7 m<sup>3</sup>/d, thereof 1,8 m<sup>3</sup>/d from a dairy farm with a milk output of 1,000 l/day or 1.8 m<sup>3</sup>/day “white” water (dairy wastewater) and a domestic wastewater connection of 0,9 m<sup>3</sup>/d.

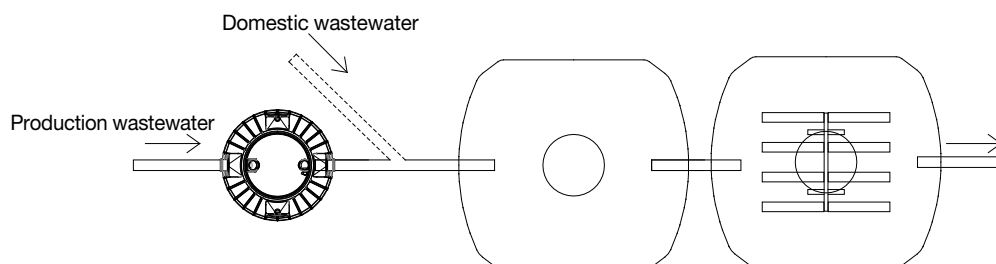

A dimension sheet for the design can be requested from KLARO.



## Wineries

The commercial wastewater from wineries stems from cleaning of production plants and can contain large debris, such as pomace, labels and cork residues, tartar and filtration residues.

Due to the seasonal production of wine, the wastewater volumes, loads and pH-values can vary considerably.

Due to the advantageous COD/BOD ratio, the wastewater is considered as easily biodegradable and demonstrates low P and N contents.

The inflow values can rise up to BOD<sub>5</sub> 4,000 mg/l. Often, there is a combined inflow of domestic and commercial wastewater.



Reference project for up to 12 m<sup>3</sup>/d, winery on page 56.

## Process concept

Due to seasonal peak load during grape harvesting, a two-line SBR process is recommended. Large debris such as pomace must be retained even before the waste water enters the treatment stage.

A preliminary treatment plant prior to bio-degradation fulfils the following functions:

- retention of large debris: equalisation of fluctuating inflow values
- storage of inflow water
- sludge storage

## Example of plant

Example of a plant for up to 13,5 m<sup>3</sup>/d for a winery with a wine output of 100,000 l/wine per year.

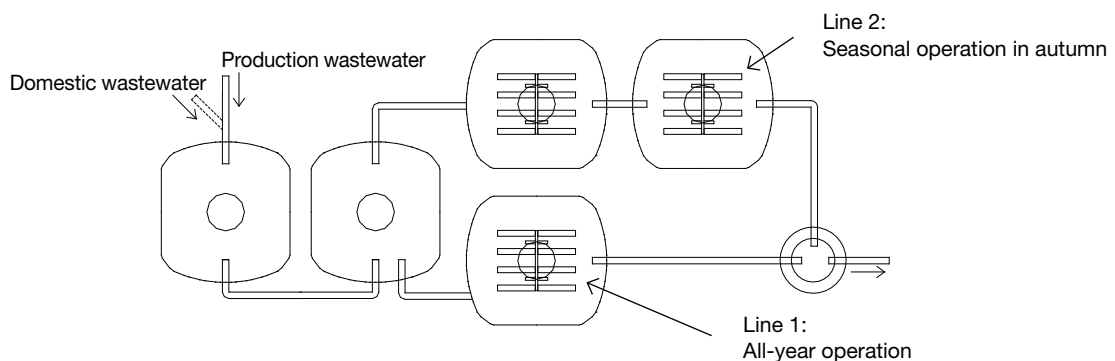

A dimension sheet for the design can be requested from KLARO.





# COMPONENTS

Components of a sewage plant	28
Switch cabinet types	30
Alternative to switch cabinet	31
Mounted parts in the switch cabinet	32
Control cabinet	34
Controllers	36
Compressor	37
Expansions	38
Flow chart of a sewage plant	42

# Components of a sewage plant

## Overview of the individual components

A KLARO sewage plant is a system comprising high-quality, sturdy and relatively few components which are optimally adjusted to each other. They are assembled or adjusted individually for each project depending upon the specific requirements.

### 1 Aeration unit

The aeration unit consists of diffuser bars and membrane diffusers.

Diffuser bars as well as piping and fastening material are made of high-grade stainless steel.

The diffusers have fine perforations and deliver highly effective, fine-bubble aeration.

The membrane is composed of plasticiser-free EPDM.

Thanks to its high quality, it usually has a service life of 12 years.

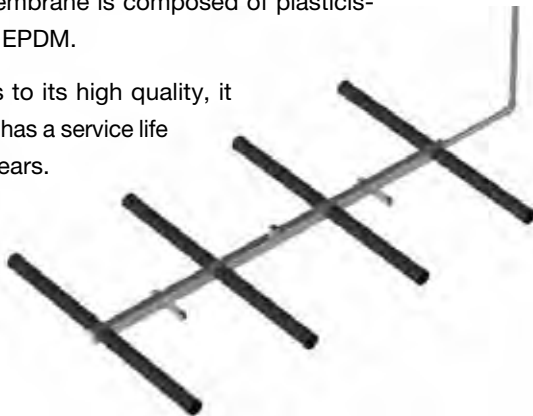

### 2 Air lifter

We distinguish between three types of air lifter: charging air lifter, clearwater air lifter and excess/sludge air lifter.

All are assembled individually: quantity, length and cross-section vary according to the specific requirements.

Material: PE or HT plastic



#### Air barrier:

A siphon at the clearwater air lifter protects against penetration of floating particles into the lifter, thereby improving the water quality.

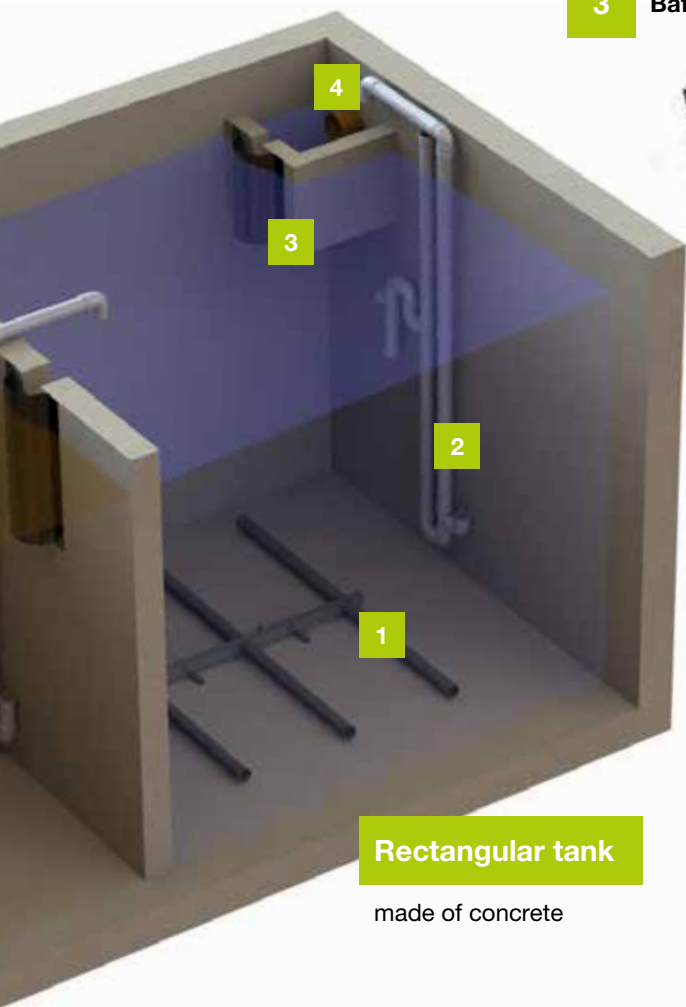

## Rectangular tank

made of concrete

### 3 Baffle



The baffle at the emergency overflow of the primary chamber prevents floating sludge from entering the biological treatment stage in the event of hydraulic overloading of the system.

### 4 Sampling point

An SBR should always be equipped with a sampling point, since only periodically clarified water leaves the plant.

KLARO sampling points are designed in such a way that the complete volume is replaced during every pump-off operation. At the same time, there is sufficient water available for extensive laboratory experiments.

The sampling points are easily accessible for extraction of bailed samples.



More information can be found in our installation instructions for treatment plants for up to 7,5 m<sup>3</sup>/d.

## Switch cabinet types

The KLARO machine technology is well housed in high-quality metallic cabinets. The switch cabinet type varies according to the compressor size and the equipment. All the components are pre-assembled and pre-wired so that the switch cabinet is delivered ready for connection.

### Outdoor cabinet 4 (7 - 28,5 m<sup>3</sup>/d)

- Size: 120 x 111 x 80 cm (WxHxD)
- Net weight: 140 kg
- Material: sheet steel 1.5 mm, powder-coated



More information can be found in our installation instructions for switch cabinets.



Also available as indoor cabinet

### Outdoor cabinet 5 (28,5 - 71,5 m<sup>3</sup>/d)

- Size: 206 x 110 x 90 cm (WxHxD)
- Net weight: 300 kg
- Material: sheet steel 1.5 mm, powder-coated



## Alternative to switch cabinet

### Within the machine room

If a machine room is available on site, the compressor, control cabinet and valve modules can be ordered even without a cabinet. This represents a cost-saving alternative and also has the advantage that the components can be arranged individually.

The machine room must be sufficiently large, dry, dust-free and well ventilated.

We recommend this solution for areas with high temperatures and humidity.



Machine room

### Within the machine house

Another alternative is to install the entire technology in a machine house next to the plant. You can also construct a completely new machine house according to our specifications.



Machine house next to the plant



Power distribution board, switch cabinet, UV module

## Mounted parts in the switch cabinet

The customisable KLARO switch cabinets are equipped with high-quality components. The centrepiece of the switch cabinet is the KLARO controller (see page 36), which not only ensures optimal operation but also permits easy and user-friendly access. Each switch cabinet comes with an original operating manual.

### External alarm

Optionally available in different versions, e.g. as LED flashing light or as warning light buzzer.

### Roof slope

for rainwater run-off.

### Remote monitoring

via wireless modem (*only in Germany, countries of the EU, Norway and Iceland*) or LAN connection. (see page 40)

### Double socket

### Control cabinet with main switch

for controlling and monitoring the operation. See page 34.

### Outdoor cabinet 4

made of powder-coated metal

### Base board for I-cabinets

One side can be removed for entry of hoses and cables.

### Dosing technology

Dosing pump and precipitants. (detailed information can be found on page 38)





### Valve bank

for air distribution with step motor or solenoid valve technology.

### Advantages of step motors:

- practically wear-free
- actuation with 24V DC
- almost noiseless and minimum current consumption
- minor pressure loss due to large stroke (length of stroke)

### Eye bolt

(unscrewable) for easier relocation.

### Seal

Wraparound profile seal on the doors.

### Sound insulation

### Cylinder lock



### Fan

for cooling and fresh air supply, temperature-controlled.

### Empty conduit opening

In the floor, for entry of air hoses and electric cables.

### Compressor with non-return valve

for operation of the air lifter and the wastewater aeration. See page 37.

- supported on rubber pads
- easily accessible for maintenance

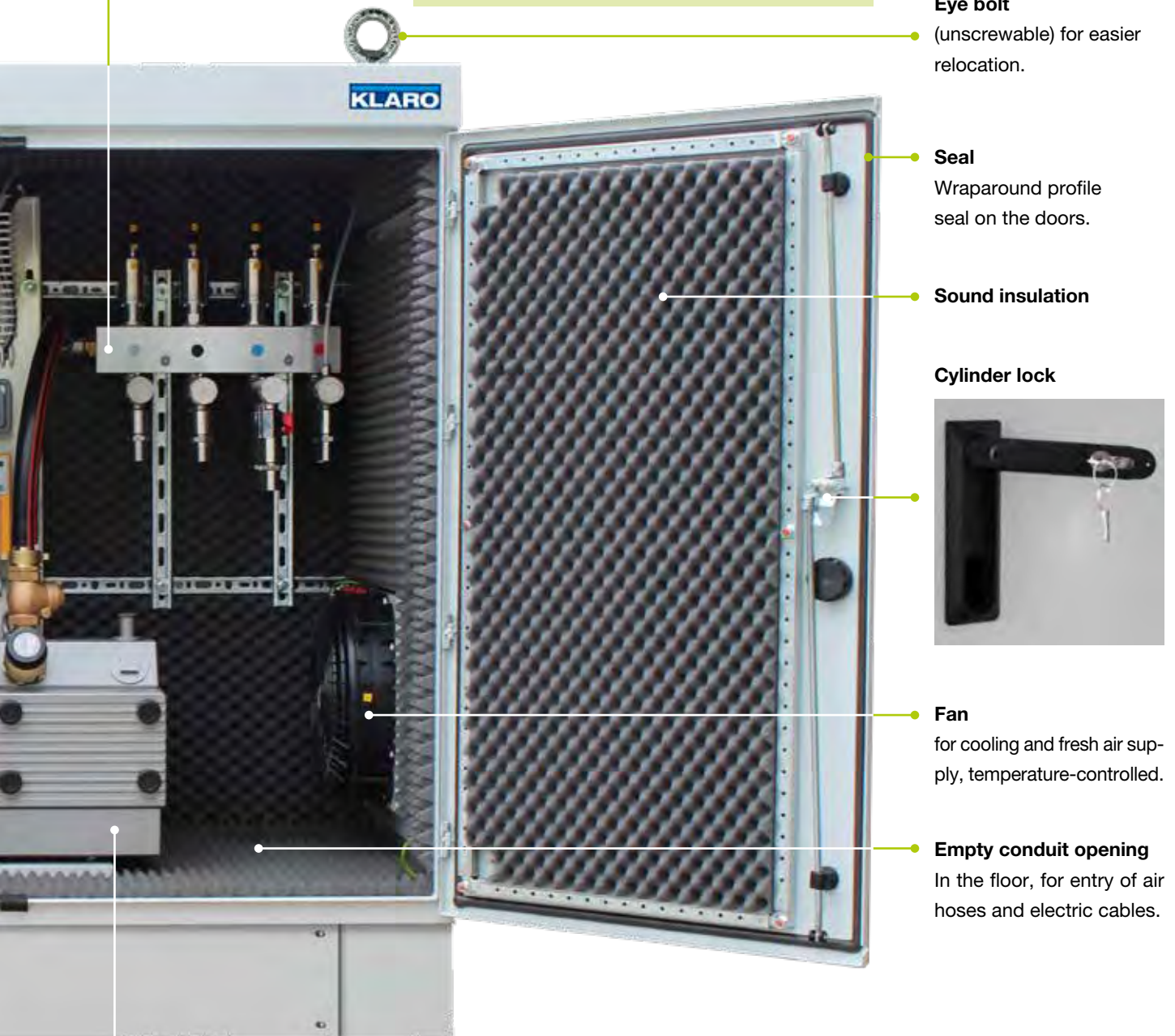

## Control cabinet

The KLARO control cabinet meets the basic requirements of Machinery Directive 2006/42/EC, EMC Directive 2014/30/EU and Low Voltage Directive 2014/35/EU, based on application of harmonised standards. All the connectors are fitted and pre-wired in such a way that the cabinet is ready for connection to the on-site power supply system. All the aforementioned electrical components are arranged in the cabinet so as to ensure that they are shock-proof. The valves and compressor are controlled and monitored from here.

### 1 Control cabinet with main switch



### 2 Motor overload switch

If current consumption is too high, the motor overload switch trips. The tripping current is adjusted to the current consumption of the specific compressor. It also serves as short-circuit protection.

### 3 Soft-starter

The soft-starter permits slow switch-on of motor voltage. This reduces mechanical and electrical loads on the compressor. This is beneficial for minimising gearbox, bearing and carbon vane wear.



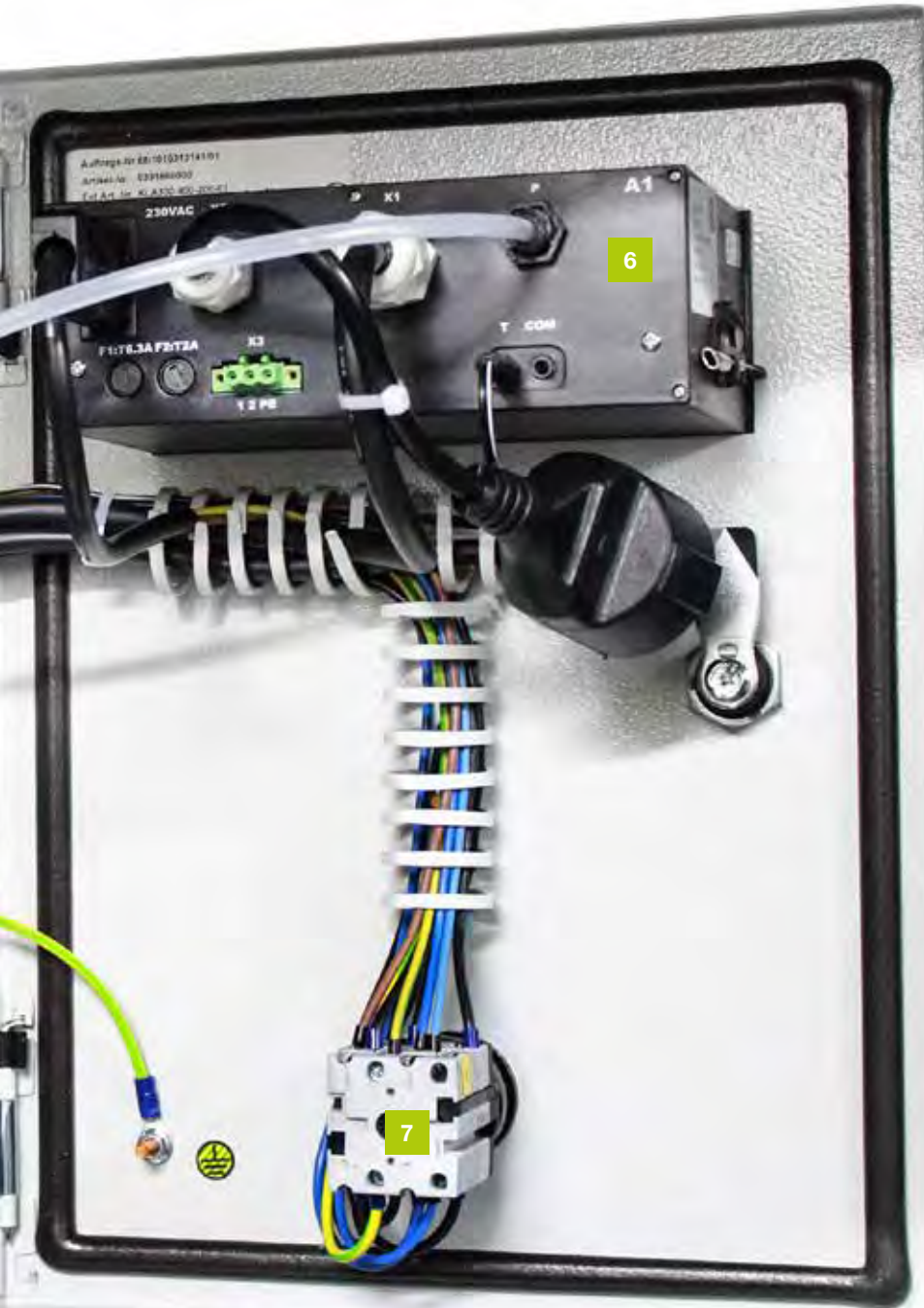

#### 4 Board

for receiving and transmitting the 24V control signals.

#### 5 Terminal

feed cable

#### 6 Controller KL40plus and KLplus



(More information on page 36)

#### 7 Main switch

This switch is used to disconnect all phases of the plant from the power supply.

#### Electric circuit diagram

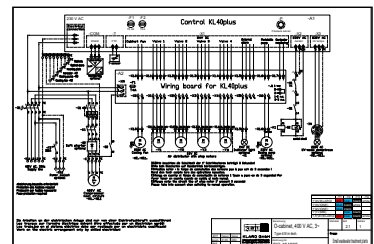

The control cabinet is accompanied by a corresponding electric circuit diagram.

## Controllers

KLARO offers proprietary, sophisticated controllers, which are widely popular in the branch of industry. The devices have been constantly further developed and improved by us over the years, though the structure and the concept has been retained. The controllers are easily understandable, very user-friendly and available in 11 different languages.



### Hardware

- large graphic display with background lighting
- operating status signal lamp, green/red
- gas-tight, membrane keypad
- SD card interface for readout of operating data
- visual and acoustic alarm
- power failure bridging through buffer capacitor
- mains input 230V
- outputs 230V for compressor, UV, pump
- outputs 24V for valves, fans, dosing pump  
extern. alarm
- output RS232 for communication
- temperature sensor and pressure sensor
- microfuses
- all connections plug-in type

### Software

- real-time control
- with preset, editable work cycles
- monitoring functions (power failure, compressor, valves, temperature, pressure, etc.)
- comprehensive logbook function
- ease of operation

#### Operator layer with:

Operating hours meter and manual operation function, economy mode, logbook view, etc.

#### Service layer (code-protected):

Cycle times and operating sequences, temperature limits, dosing and UV technology, fill level measurement, restart and function test, monitoring functions ON/OFF, languages, service, etc.

#### Manufacturer layer (code-protected)

## Compressor

In large-sized plants, rotary vane compressors are normally used, which are particularly sturdy and reliable.

They provide a stable air flow rate which is largely independent of water depth. This is a decisive advantage especially in SBR's. Only branded compressors by German manufacturers are used. Wear parts such as carbon vanes and air filter are always in stock in all sizes.



### Technical data:

	DT 4.25 K	DT 4.40 K	DTN 41	KDT 3.60	KDT 3.80	KDT 3,100	KDT 3.140
Figure							
Dimensions [L x W x H mm]	545 x 328 x 290	625 x 328 x 290	592 x 270 x 282	709 x 353 x 328	709 x 353 x 328	873 x 470 x 336	895 x 470 x 336
Weight [kg]	36.5	46	48.4	71	85	129	140
Installed motor output [kW]	1.10	1.7	1.5	2.4	2.4 (to 0.5 bar) 3.0 (to 1 bar)	4.0 (to 0.5 bar) 5.5 (to 1 bar)	5.5 (to 0.5 bar) 7.8 (to 1 bar)
Air flow rate [m <sup>3</sup> /h]	24	40	43	54	66	99	129
Frequency [Hz]	50/60	50/60	50/60	50/60	50/60	50/60	50/60
Operating voltage	230 V, 1~ 380 V, 3~	230 V, 1~	380 V, 3~	380 V, 3~	380 V, 3~	380 V, 3~	380 V, 3~

# Expansions

## P-Elimination

P

### P-module

KLARO P-modules are used for simultaneous phosphate precipitation (SBR). A dosing pump in the switch cabinet doses a precipitant directly on start of the aeration phase. This immediately results in good mixing. The precipitant creates an insoluble compound with the phosphate, which settles well in the tank.

The P-module consists of a dosing pump as well as suction and pressure hose. Useful accessories are also available, such as suction aids or drip trays for the jerry can. Polyaluminium chloride is recommended as precipitant. We offer different dosing pumps depending upon your requirements.

The dosing can be set for the runtime of the pump in the KLplus controller or can be adjusted via a speed governor.

- Discharge values  $P_{total} = < 1 \text{ mg/l}$
- Mean value for CE test  $P_{total} = 0.4 \text{ mg/l}$



### Technical data

	Pump Compact	Pump Concept
Pumping capacity [ml/min]	2.5 - 75	2 - 150
Operating voltage	230 V, 50 Hz	230 V, 50 Hz
Power [W]	5	16

## Balancing of C-deficiency

C

### C-module

With the C-module carbon can be injected to the SBR chamber to equalise any deficiency. This can resolve any problems occurring in phases of extreme underload or disadvantageous waste water composition. Thus, for instance, a desired quantity of activated sludge can be kept stable in the system, even if there is no waste water inflow for months. Or else, if there is incomplete denitrification due to a natural C deficiency and excess N, the disadvantageous ratio can be balanced and the clarification target can be achieved.

The C-module consists of a dosing pump with high pumping capacity as well as suction and pressure hose. As C-source, we offer a growth medium that is especially effective (COD  $\approx 1,000,000 \text{ mg/l}$ ), safe and completely biodegradable.

Dosing usually takes place in parallel with excess sludge return or recirculation. Other phases are also possible depending upon the use case. The dosing can be set for the runtime of the pump in the KLplus controller or can be adjusted via a speed governor.



### Technical data

	Pump DP12
Pumping capacity [ml/min]	50
Operating voltage	230 V, 50 Hz
Power [W]	5

## Disinfection with UV

UV

### UV-Modul

KLARO UV modules are used for disinfection of biologically pre-treated waste water. The use of ultraviolet radiation (UV) is an effective and user-friendly method. UV light kills pathogenic bacteria within seconds without leaving any residues, harmful by-products, or odours.

The module consists of an submersible pump, a UV reactor made of stainless steel and a ballast (starter box).

KLARO offers UV systems in various sizes and versions.

The modules are installed in a tank or externally in dry conditions in a machine room. They can be time-controlled and monitored via the controller or level-controlled by a float switch.



## Technical data

	Modul S50	Modul S80
Nominal flow [l/min]	18	43
Radiation dosage [l/m <sup>2</sup> ]	> 400	> 400
Power [W]	75	95

- Discharge values:  
Faecal coliform bacteria < 100/100 ml
- Mean value for CE test: Faecal coliform bacteria 10/100 ml

## Disinfection with chlorine

Cl

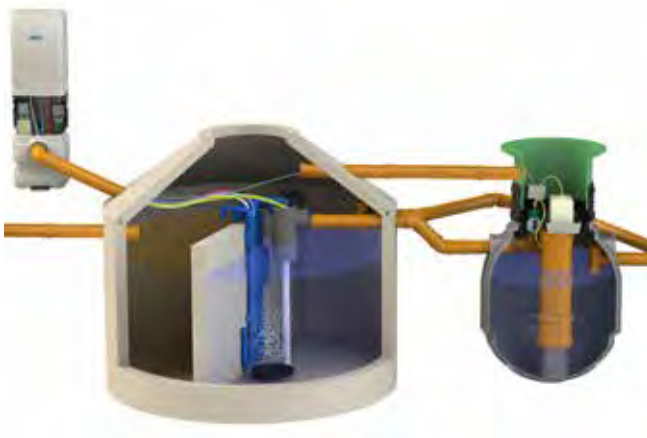

### KL e-chlorination

Health considerations as well as legal regulations often lead to the need of a safe and reliable disinfection of secondary effluent. Chlorination is the worldwide most established method for the effective kill of pathogens in the wastewater. The KL e-chlorination module works with liquid chlorine and prevent a recontamination with its storage effect. The module uses electrodes, which activates the chlorine dosing if it's needed. The system has no connection to the control and is mounted in the contact tank. This allows a big flexibility, so the KL e-chlorination can be installed after a SBR-plant or a continuous running system.

### Advantages

- Disinfection with a widely available sodium hypochlorite solution
- Safe and easy handling of the chlorine
- Plant-specific dosing with the chlorine dosing pump
- Module runs without a control connection – easy retrofitting
- No electric parts in the bio reactor necessary
- Modular principle: one module up to 500 PE – easy upscaling with parallel connection
- Total coliforms will be nearly completely killed

### Facts

- For plants up to 500 PE / 75m<sup>3</sup>/d
- No electric parts in the bio reactor necessary
- No submersible pump needed
- Expandable and easy maintenance
- The system is independent of the plant control
- Resistant electrodes

# Expansions

## Sludge treatment

SDM

### Sludge dewatering module

The sludge dewatering module is offered for remote and isolated places where sludge removal from site is complicated. Through dewatering and drying of the sludge, the volume and weight are reduced. A flocculant is added to the drawn-off sludge for quick separation. The drying phase begins after the filter bag is full. For that, a hood with fan is drawn over the frame.



Residual sludge volume after dewatering of 5 m<sup>3</sup> activated sludge over a period of 3 months. **KLARO One system, KLARO SBR tank system**

### Technical data

	Data
Filter bag frame dimensions [L x W x H mm]	1200 x 1200 x 1700
Capacity	approx. 10 m <sup>3</sup>
Pump unit dimensions [L x W x H mm]	820 x 620 x 550

	Impeller pump
Nominal volume flow [l/min]	115
Operating voltage	230 V, 50 Hz
Connected load [W]	1500

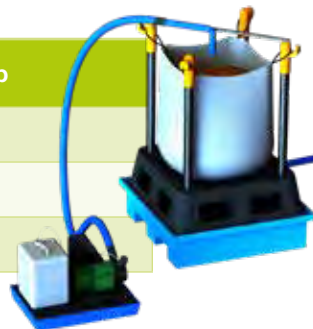

## Remote monitoring

WM

### WebMonitor



The KLARO WebMonitor<sup>®</sup> comes in useful whenever highest level of operational reliability and stress-relief of the operator are desired at the same time. The plant can be monitored by a maintenance firm via a remote diagnostic system. In the event of a fault, intervention is possible immediately from home via internet.

**The KLARO WebMonitor<sup>®</sup> offers many advantages for the operator and for our partners!**

- higher customer benefit due to monitoring service
- cost-effective remote diagnosis in the event of a fault
- higher effectiveness and higher operational reliability
- optimised service intervals

### Technical data

	Modem and LAN adapter
Communication:	GPRS*, LAN
Notification	SMS, email
Signal transmitter	Multicolour LED green, orange, red, Off

\* only in Germany, countries of the EU, Norway and Iceland





## Grease separator

G

### KLsepa.pop

In hotels, restaurants and similar places where food is cooked or meat is processed for commercial purpose, the wastewater must be separated from grease with a grease separator. In the KLsepa.pop, KLARO offers a compact grease separator in nominal size (NS) of 1 to 15 in a plastic tank, which can be included upstream of the treatment plant.

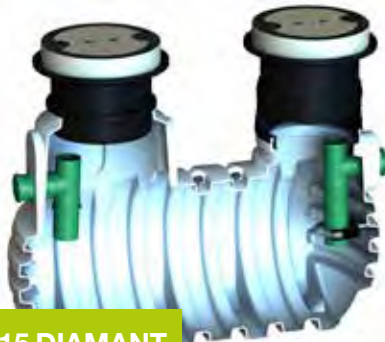

NS 4 - 15 DIAMANT

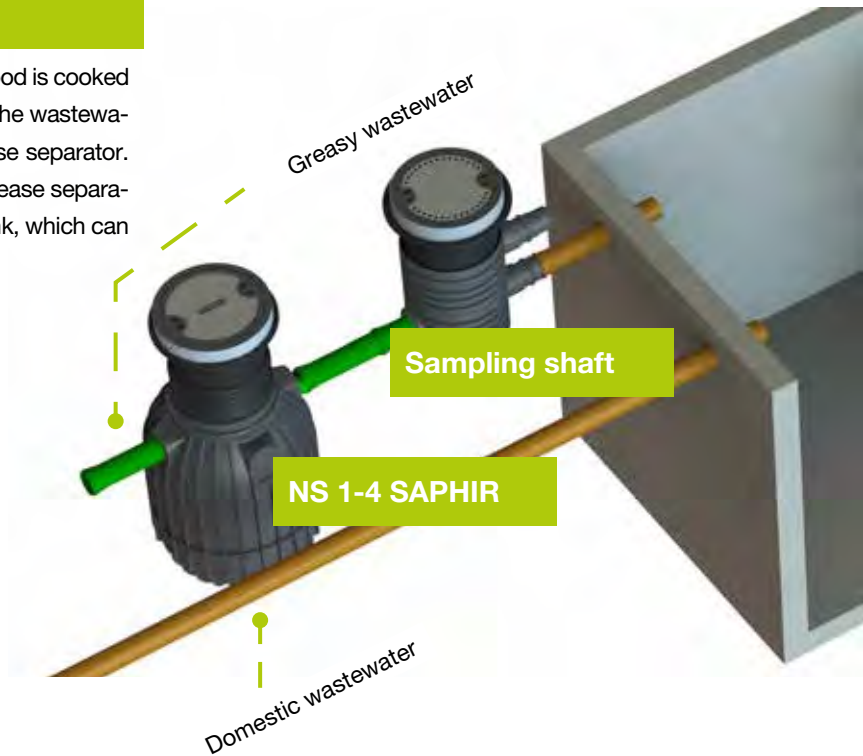

NS 1-4 SAPHIR

### Technical data: NS 1 - 4 SAPHIR

NS [l/s]	DN [mm]	Volume			Tank geometry	
		Grease [l]	Sludge [l]	Total [l]	D [m]	H* [m]
1 - 200 / 2 - 200 - 2	110	200	200	500	1.13	1.04
2 - 200 - 3	110	300	200	730	1.16	1.34
2 - 400	110	200	400	730	1.16	1.34
2/4 - 500	110	300	500	1025	1.16	1.67

### Technical data: NS 4 - 15 DIAMANT

NS [l/s]	DN [mm]	Volume			Tank geometry		
		Grease [l]	Sludge [l]	Total [l]	L [m]	W [m]	H* [m]
4/7 - 700	160	350	700	2070	2.45	1.15	1.66
10/15 - 1500	200	600	1500	3160	2.45	1.40	1.90

H\* = without cover

# Flow chart of a sewage plant

## P-Elimination

Dosing of phosphate precipitant during the aeration phase in the SBR chamber.



## Grease separator

Separation of grease from food cooked in commercial establishments or meat in butchers shops in order to avoid unpleasant odour or overloading of the plant.



## Peak load absorption

Equalisation of peak loads by including an additional buffer tank which is connected to the overflow of the pre-treatment tank.

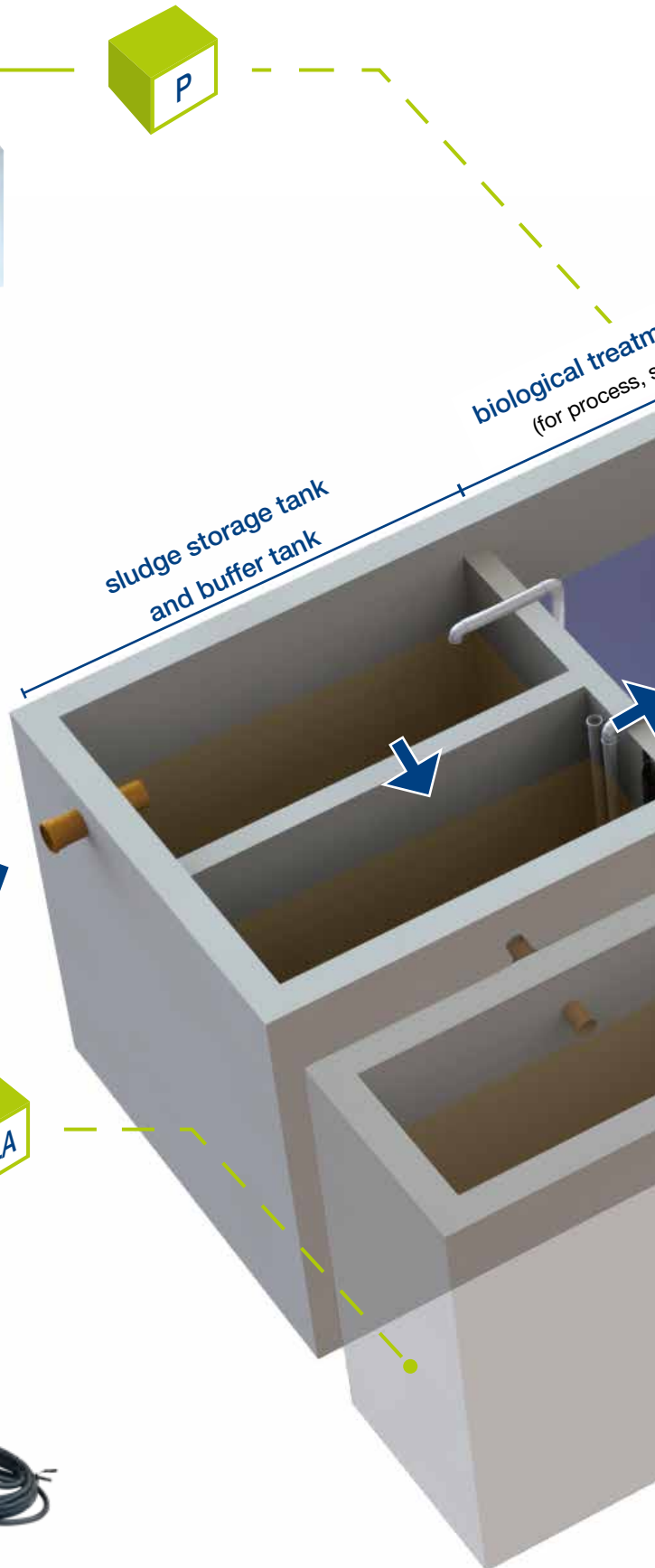

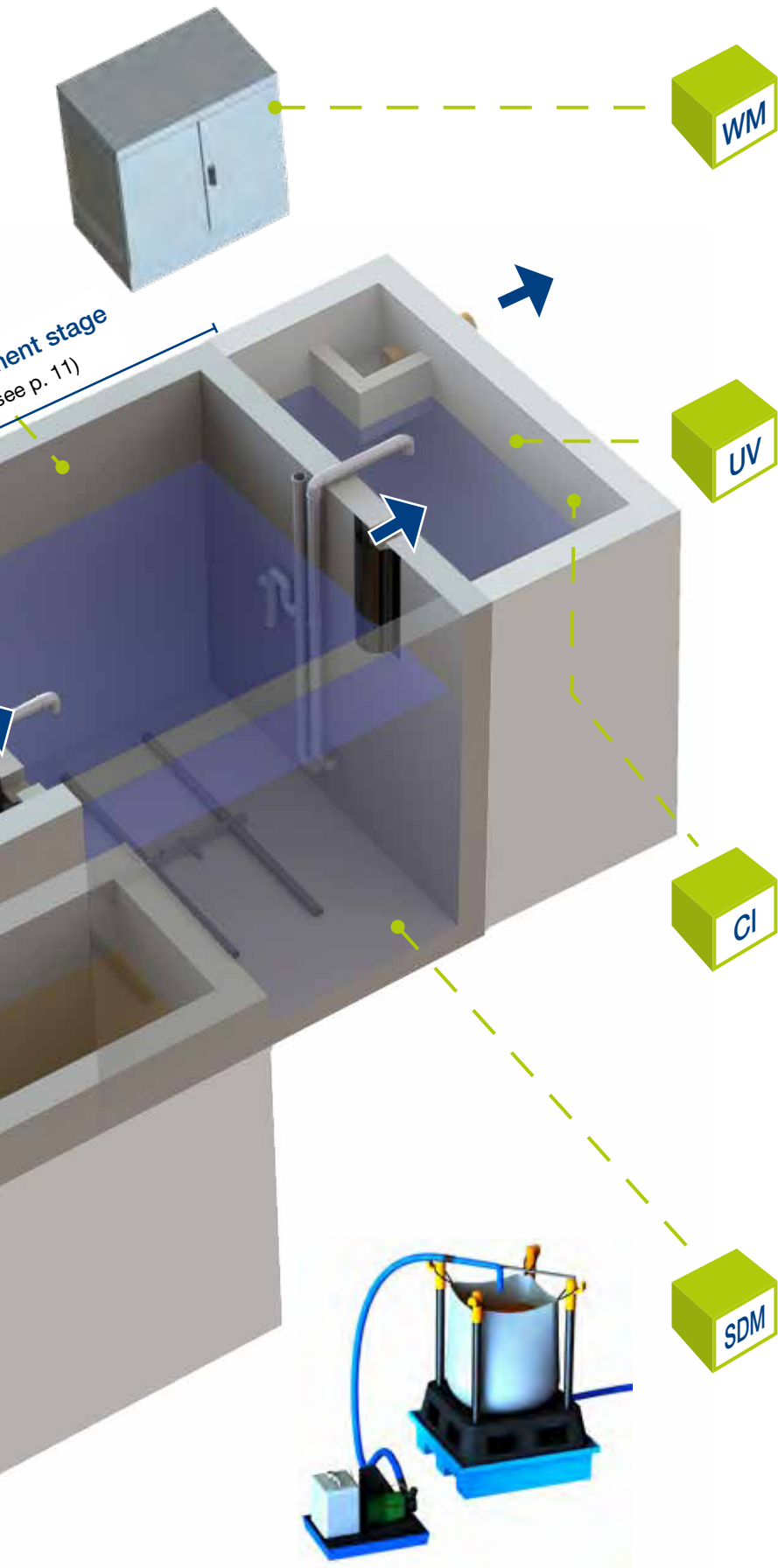

## WebMonitor



Remote monitoring of the plant and read-out of the logs via the KLARO WebMonitor.

## Disinfection with UV

In the UV disinfection process, the biologically clarified water is initially stored temporarily and then pumped to the outlet via the UV module.



## Disinfection with chlorine

In the disinfection process with chlorine, the biologically clarified waste water must flow through a chlorine contact chamber. The water can be used for irrigation.



## Sludge dewatering module

For sludge draw-off and treatment on site. Suitable only for activated sludge.

KLARO *One system*

KLARO SBR basin system



The background of the entire page is a photograph of three people standing in a large industrial warehouse. On the left, a man with long hair tied back, wearing a dark suit jacket over a light blue shirt, smiles. In the center, a woman with blonde hair, wearing a black blazer over a white top and blue jeans, laughs. On the right, a man in a dark blazer over a white shirt and blue jeans stands with his hands in his pockets. The warehouse floor is paved with grey interlocking bricks. In the background, there are rows of large, dark grey, ribbed cylindrical tanks and several pallets stacked with black plastic-wrapped materials. The lighting is bright and even, suggesting an indoor or well-lit outdoor setting.

# PLANNING & SERVICE

Project flow	46
Plant design	48

# Project flow

## Contact persons

Our specialists from the technical department are available and pleased to answer your questions at any time.



Technical manager  
Dipl.-Ing. **A. Kaufmann**



Development/calculation  
Dipl.-Ing. **I. Pilarski**



Calculation/separator  
Dipl.-Ing. **U. Köhler**



Electric/switch cabinets  
B.Eng. **D. Schäfer**

## Workflow

### Enquiry ...

... by the customer, and first contact made by KLARO.

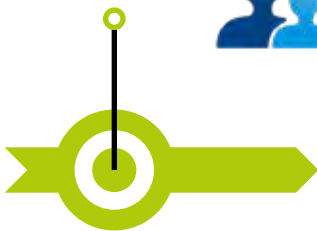

### Inform ...

... about project data, initial conditions, text of tender documents.

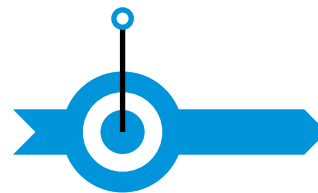

### Advice ...



... by KLARO. Demonstration of the products as well as their advantages.

### Dimensioning...

... of the plant according to the customer's specifications and the legal requirements.





Product management  
M.Sc. **M. Uruñuela**



Technical hotline  
B.Eng. **J. Kuhlemann**



Service/complaint  
**P. Hofmann**

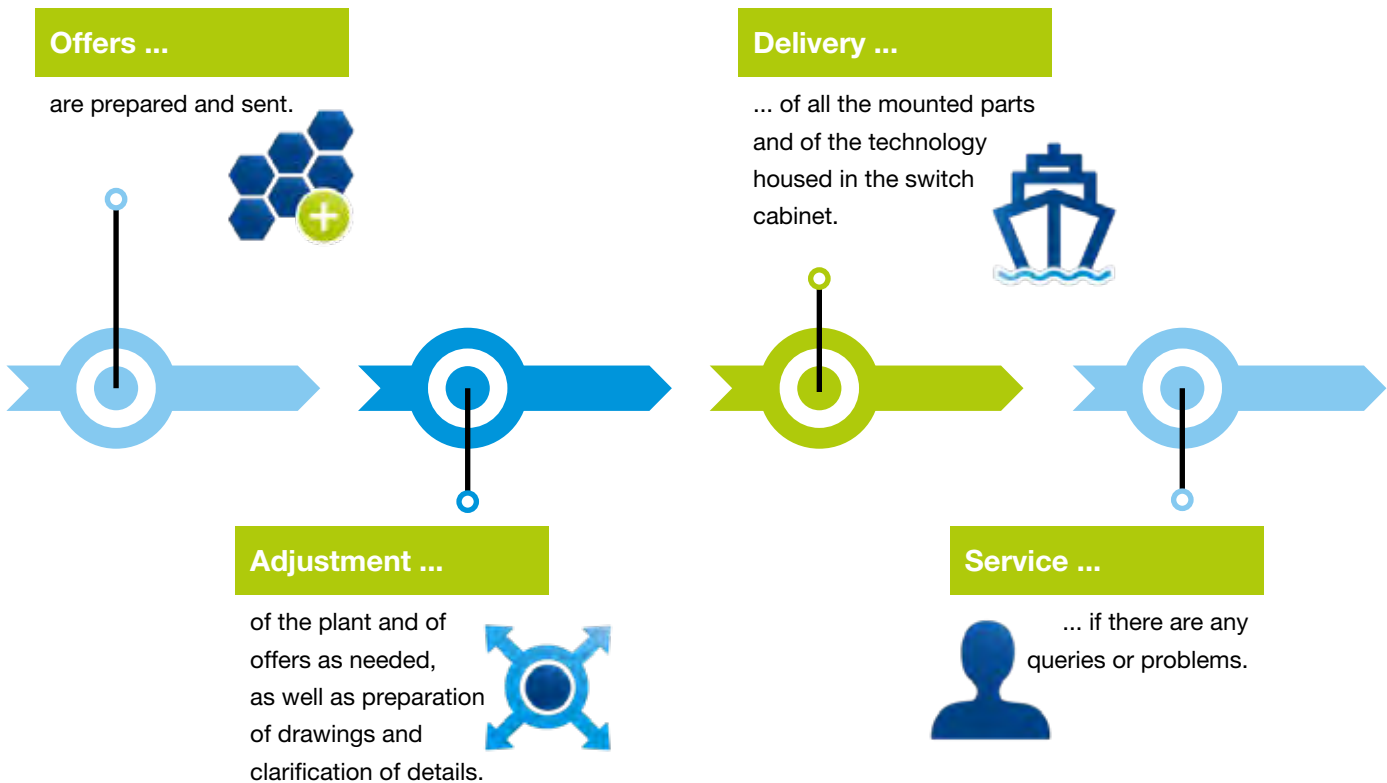



28,5 m³/d hotel Post

## Plant design

The plant designs at KLARO are based on the relevant standards and guidelines on the one hand (EN, ATV, Austrian standard, VSA, ... ) and on many years of experience in handling of projects of this kind on the other hand.

For each project, waste water related technical data is prepared, providing information about the most important plant parameters.

KLARO GmbH	
<b>Technical data sheet for KLARO-SBR wastewater treatment plant according to ATV-A122</b>	
KLARO GmbH Schneidmühlweg 13 D-33629 Bielefeld Tel: +49 (0)51 9279-0 E-Mail: info@klaro.de	plant size 200 PE Minimum hydraulic load Q <sub>min</sub> 35,00 m³/d Maximum hydraulic load Q <sub>max</sub> 13,25 m³/d
Design according to ATV-A122	
<b>effluent values:</b>	
BOD5	50 mg/l
COD	150 mg/l
SS	30 mg/l
NH4-N	10 mg/l
Nitrit	0 mg/l
P	0,5 mg/l
costs	per m³
total plant capacity	200 PE
plant depth	4,00 m
plant width	2,00 m
plant length	10,00 m
plant area	20,00 m²
plant volume	80,00 m³
plant weight	10,00 t
calculated maximum SBR operating time	1 hour 30 min
	92,5 h/a

calculation for KLARO-SBR wastewater treatment plant according to ATV-A122	
plant size	200 PE
plant depth	4,00 m
plant width	2,00 m
plant length	10,00 m
plant area	20,00 m²
plant volume	80,00 m³
plant weight	10,00 t
calculated maximum SBR operating time	1 hour 30 min
	92,5 h/a



- **Guest houses, hostels/inns:**  
1 bed = 0,15 m³/d



- **Camping and caravan parks:**  
2 persons = 0,15 m³/d



- **Restaurants:**  
3 meals = 0,15 m³/d



- **Clubs:**  
5 visitors = 0,15 m³/d
- **Sports grounds:**  
30 visitors = 0,15 m³/d





- **Commercial establishments:**  
2 workers = 0,15 m³/d
- **Office blocks:**  
3 employees = 0,15 m³/d



## Calculation of plant size

For an exact calculation of the plant size, we need as much information as possible on the following points:

<b>?  Domestic or  commercial wastewater</b>	<b>? Available space [m]</b>
<b>? Inflow values for BOD, COD, ammonium, phosphate [mg/l]</b>	<b>? Tank material: plastic or concrete</b>
<b>? Maximum hydraulic load [m<sup>3</sup>/d]</b>	<b>? Above-ground or underground erection</b>
<b>? Weekend and seasonal loads [m<sup>3</sup>/d]</b>	<b>? Discharge values [mg/l]</b>
<b>? Infiltration water [m<sup>3</sup>/d]</b>	<b>? Switch cabinet type: indoor, outdoor, machine technology</b>

## Examples of typical country-specific discharge values abroad:

	BOD <sub>5</sub> [mg/l]	COD [mg/l]	NH <sub>4</sub> -N [mg/l]	AFS [mg/l]	P [mg/l]
Switzerland	-	90	3	-	-
United Kingdom	20	-	20	30	-
France	30	90	-	35	-
Norway	20	-	-	-	1





**REFERENCES**

---



## Commercial wastewater



The wastewater on an organic farm is composed of multiple wastewater types. Besides domestic wastewater generated by permanent residents, it is also composed of wastewater generated in a few holiday homes. The plant is connected to a dairy plant with 35 cows which are milked twice daily. In total, the plant has a capacity of 25 PE.

On the dairy plant, roughly 1m<sup>3</sup> commercial wastewater is generated daily from the cleaning process. The dairy plant is flushed once each with acidic and alkaline cleaning agent. Before the cleaning water reaches the primary treatment, it initially flows through an upstream buffer tank where the water can neutralise.



The KLARO sewage plant has been running uninterrupted since the beginning and has been delivering an excellent performance.

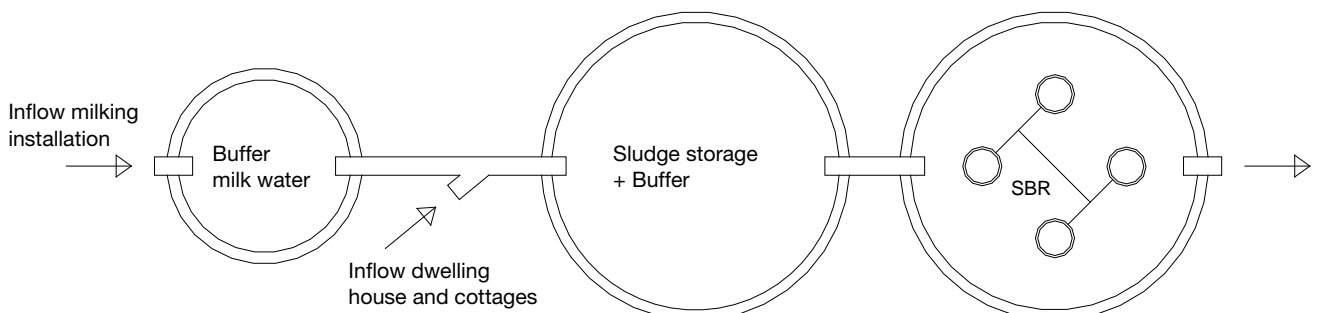

## Information

Tanks: Concrete  
 Compressor: DT 4.10  
 Commissioning: 2008  
 Inflow: domestic, industrial



## Discharge values

Parameters	22/04/ 2014	20/10/ 2014	13/03/ 2015	22/09/ 2015	18/05/ 2016	31/10/ 2016	25/04/ 2017
COD [mg/l]	49	37	50	34	7	21	37





The old septic tank of a school in Trynserum from the 60's no longer met the requirements and had to be replaced. At that time, the municipality decided in favour of KLARO technology, out of many competitors.

At the time of construction, 90 pupils were being taught in the school by 18 teachers. Based on the calculation of office employees, 3 pupils/teacher with 1 PE were calculated.

In addition to the school, a few residential units, holiday homes and a church were also connected to the plant, resulting in a plant with a total capacity of 60 PE.

The wastewater is predominantly generated during daytime. It is stored intermediately in the buffer area of the first two tanks. The evening and night-time cycles ensure that the water is processed by next morning and the buffer tank is emptied for the next day of school.

Carat S tanks were selected here as clarification tanks, since they are stackable, and therefore can be delivered to Sweden without taking up much space. There, the tanks were assembled by a specialist partner and mounted using a KLARO mounting kit. The plant has a phosphate precipitation stage, which is standard in Sweden.

#### Tank data: GRAF clarification tank Carat S

- plastic tanks available as half-shells up to Carat 6500 l
- stackable and space-saving
- 2 half-shells are permanently joined with clamps and a seal (assembly on site)



## Information

Tanks: 4 x Carat 6500 l

Compressor: DT 4.25

Commissioning: 2014

## Discharge values

Parameters	Limit values [mg/l]	Measured values [mg/l]
BOD <sub>7</sub>	30	9
NH <sub>4</sub> -N	10	2
N <sub>total</sub>	40	20
P <sub>total</sub>	1	0.6





In Ettringen, located approx. 100 km away from Munich, an old biological treatment plant was replaced by a KLARO sewage plant, since the discharge values could no longer be maintained and unpleasant odour and flies caused a nuisance in summer.

The KLARO technology was installed in Carat XXL tanks. The tanks are available in different sizes and can be customised to your requirement.

The connected estate is a forest inn, which has a considerably high number of visitors on weekends. Up to 300 persons are expected then, whereas the number of visitors on weekdays is considerably lower.

The buffer tank of the plant is already large enough to absorb the shock loads on weekends. Therefore, the additional buffer tank was left out.

#### Tank data: Carat XXL

- Carat XXL tanks available in 16,000 to 102,000 l sizes (size up to 122,000 l available on request)
- optional with multiple tank dome roofs
- multiple connection faces DN100/150/200, optional DN300

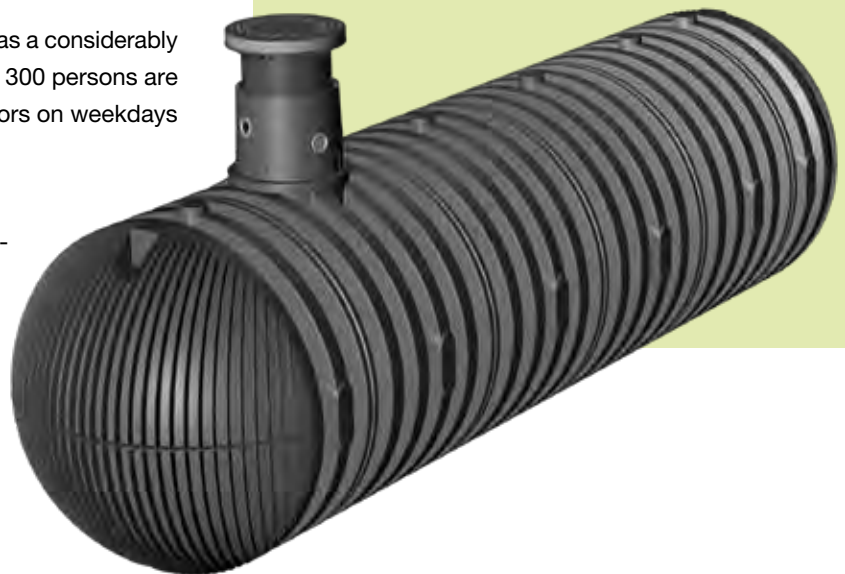



## Information

Tanks: 2 x Carat XXL 26,000 l

Compressor: DTN 41

Commissioning: 2014

## Discharge values

Parameters	Limit values [mg/l]	Measured values* [mg/l]
CSB	90	51
NH <sub>4</sub> -N	10	3.7
N <sub>total</sub>	15	5.4
P <sub>total</sub>	4	0.9

\* mean values over the period 2014 - 2017.

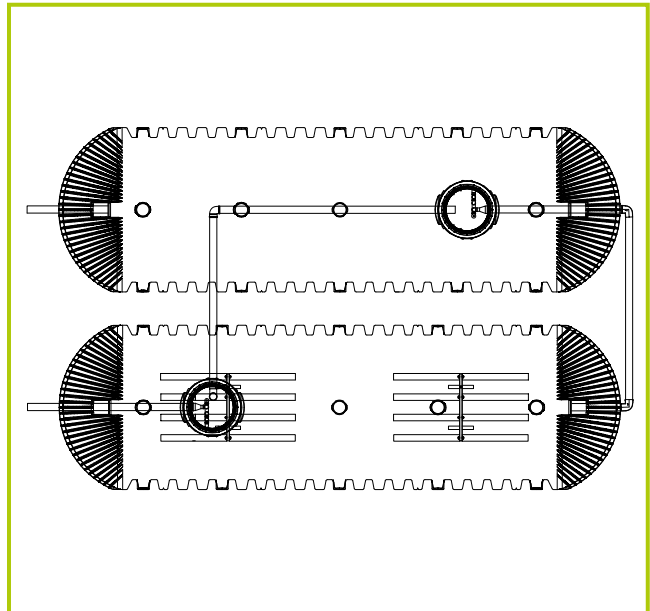



The Niederbauen mountain inn lies in the Swiss canton Nidwalden at roughly 1500 m above sea level and offers hikers the possibility of relaxation with an idyllic view of Lake Lucerne and the surrounding mountains. Besides a restaurant, overnight accommodation is also available.

Directly next to the house, there was an old septic tank whose odours were perceived to be increasingly unpleasant by the owners and visitors. With the KLARO One system, the existing single-chamber tank could be converted into a sewage treatment plant by adding only a few parts. This simplified transportation to the mountain inn which was accessible only by aerial ropeway.

Accordingly, sludge removal would also have been very problematic. For this reason, it was decided at that time to add a sludge dewatering module to the plant, which would be able to treat the entire sludge. This offers the advantage that the entire sludge can be treated with the sludge dewatering module. The sludge is pumped into a bag and dried. Later, it can be transported more easily.



## Information

Tanks: Concrete

Compressor: KDT 3.60

Commissioning: 2016



## Discharge values

Parameters	Limit values [mg/l]	Measured values [mg/l]
CSB	90	50
NH <sub>4</sub> -N *	3	< 1

\* NH<sub>4</sub>N-values especially important for the Swiss authorities.

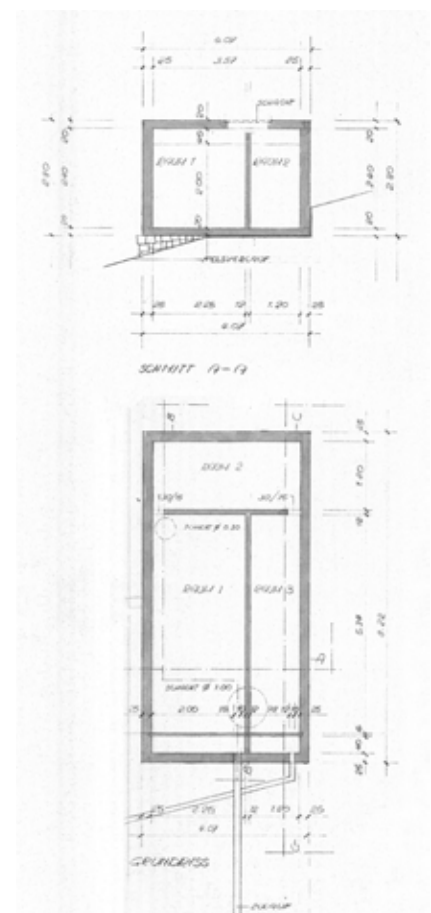
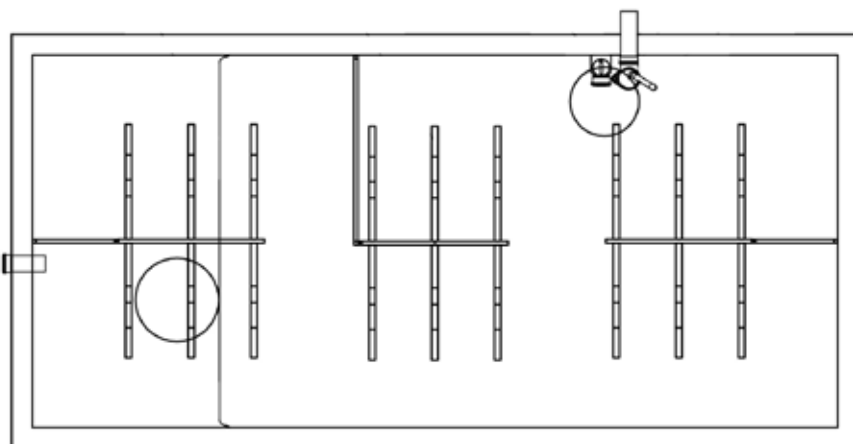
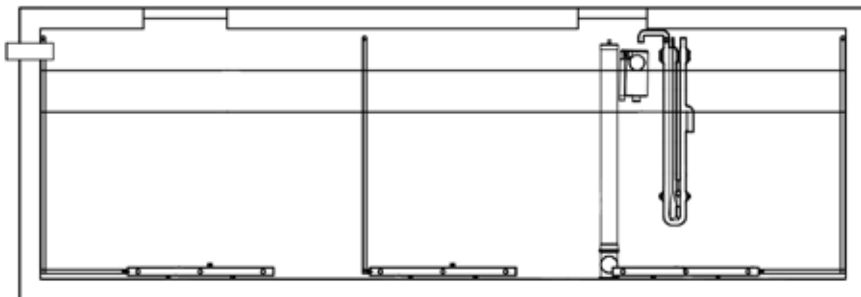



KLARO has delivered a sewage treatment plant for a winery at Lake Geneva. Three plastic tanks with pre-assembled and mounted technology were set up downstream of an existing concrete tank. The winery, restaurant and residential house generate three different kinds of wastewater, which must be clarified.

In addition to that, wine harvesting and the irregular events (wine-tasting) give rise to strong fluctuations in the wastewater volume and load. The plant was supervised by scientists in the first year of operation as part of a pilot project. This led to the conclusion that the desired strict discharge values can always be maintained by KLARO even in peak load times.

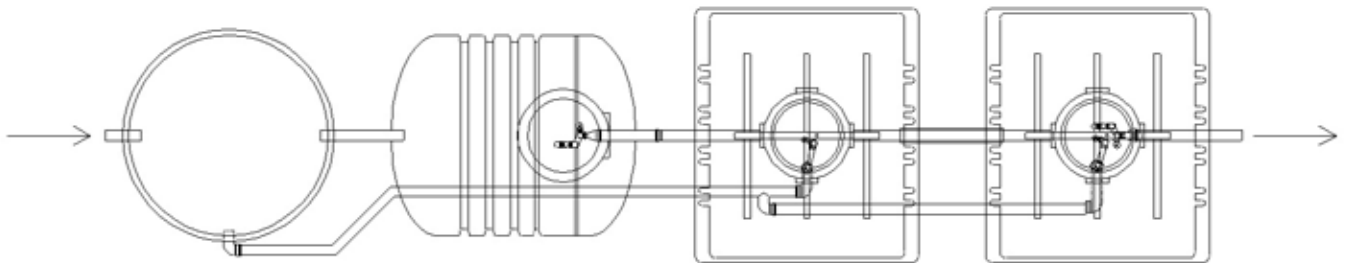

## Information

Tanks: Concrete, Diamant 6,500 l + 9,200 l

Compressor: DTN 41

Commissioning: 2008

## Discharge values

Parameters	13/10/ 2008	13/05/ 2009	15/06/ 2010	04/11/ 2011	25/04/ 2012	17/09/ 2013	01/05/ 2014	28/04/ 2015	28/09/ 2016	24/04/ 2017
COD [mg/l]	52	33	48	14	11	11	14	9	40	28
NH <sub>4</sub> N [mg/l] *	1.91	1.31	2.24	0.32	0.12	< 0.20	0.13	0.24	< 0.2	< 0.2

\* NH<sub>4</sub>N-values especially important for the Swiss authorities.





Interest in sustainable treatment and environmental protection has been steadily increasing in the industrial sector. Paper factories have a high water consumption rate due to their paper manufacturing process. Here, there is a possibility of reusing the process water for paper manufacturing. For that, it is necessary to separate domestic water from process water.

Here, the wastewater flow from office buildings was separated from the process water flow and a separate 22,5 m<sup>3</sup>/d plant was constructed next to the existing large plant. Thus, the company has two treatment plants, one for industrial wastewater and one for domestic wastewater. The plant was integrated in four round concrete tanks and is supervised by the company's own wastewater treatment plant operator.



## Information

Tanks: Concrete  
 Compressor: KDT 3.60  
 Commissioning: 2013



## Discharge values

Parameters	Limit values [mg/l]	Measured values [mg/l]
BOD <sub>5</sub>	40	< 10
CSB	150	< 60

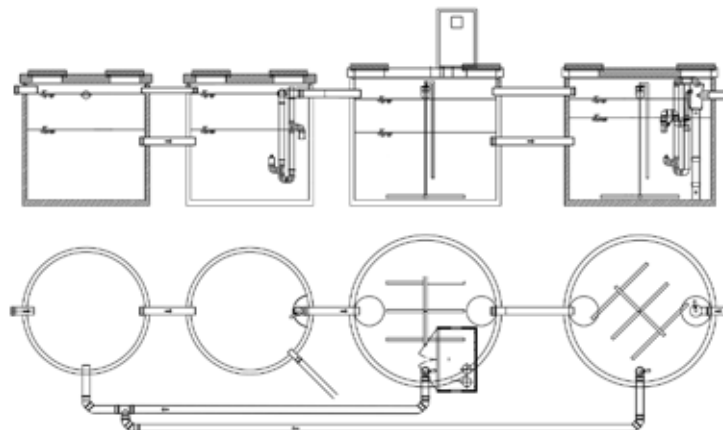



The Samoan islands lie in the middle of the Pacific Ocean. The isolation and seclusion offers a perfect opportunity to tourists to forget the daily routine and allow the soul to unwind. Increased tourism led to a shift towards creation of artificial islands such as Taumeasina island and developing them into resorts. Naturally, it also became necessary to find a suitable wastewater treatment solution. Avoidance of daily sludge disposal and unpleasant odours was desired.

Finally, it was decided to install four sewage treatment plants by KLARO, the largest of them having a capacity of 150 PE. Since the islands were very difficult to reach and concrete plants are difficult to procure and also expensive, it seemed advisable to conceive the plant in plastic half-shell tanks. These are particularly suitable for transport since they are stackable. This was a decisive reason for the installation of a plant in a plastic tank.





## Information

Tanks: 10 x Carat 6,500 l

Compressor: KDT 3.80

Commissioning: 2015

## Discharge values

Parameters	Limit values [mg/l]	Measured values [mg/l]
BOD <sub>5</sub>	20	< 10
AFS	30	< 10

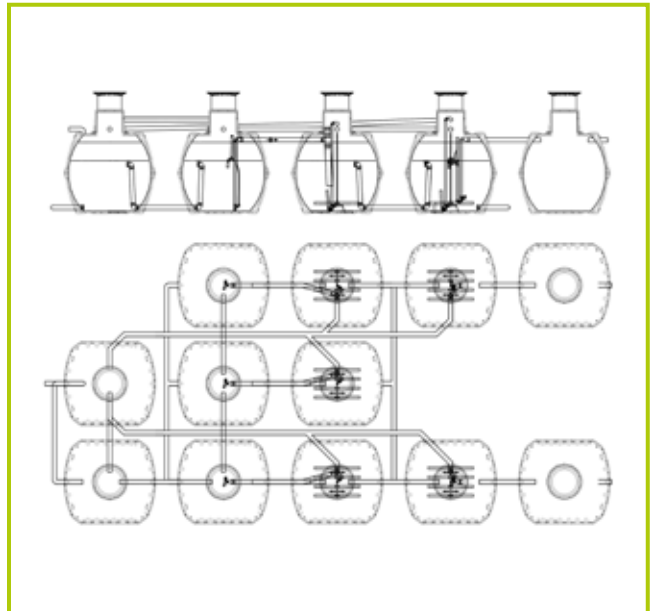



The Caravan Park in Aberdeenshire offers overnight accommodation in holiday homes in addition to a few large camping sites.

The plant was initially constructed for 45 m<sup>3</sup>/d and will be expanded to 90 or 135 m<sup>3</sup>/d in the near future. All 3 plants are constructed in the same way and the same tanks will be added during an expansion.

The overall plant arrangement will be in 3 lines. All the pre-treatment tanks will be connected via underwater connection, whereas the SBR tanks of the three lines are separate. Thus, all three lines can be operated independent of each other.

Not only small sewage treatment plants can be delivered pre-assembled. The large plants in XXL tanks can also be delivered by us in pre-assembled condition.

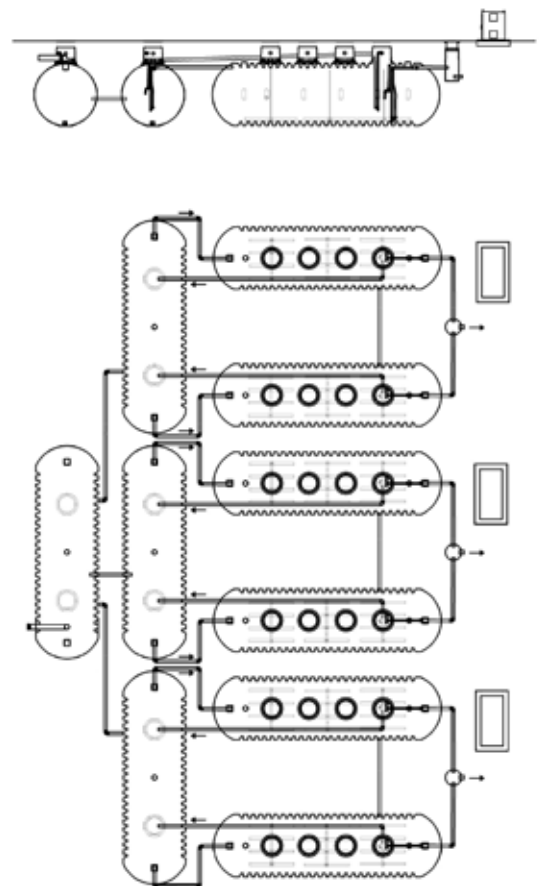

## Information

Tanks: 2 x Carat XXL 32,000 l + 2 x Carat XXL 34,000 l

Compressor: KDT 3.140

Commissioning: 2017

## Discharge values

Parameters	Limit values [mg/l]	Measured values [mg/l]
BOD <sub>5</sub>	20	< 10
AFS	30	< 15
NH <sub>4</sub> -N	20	< 5

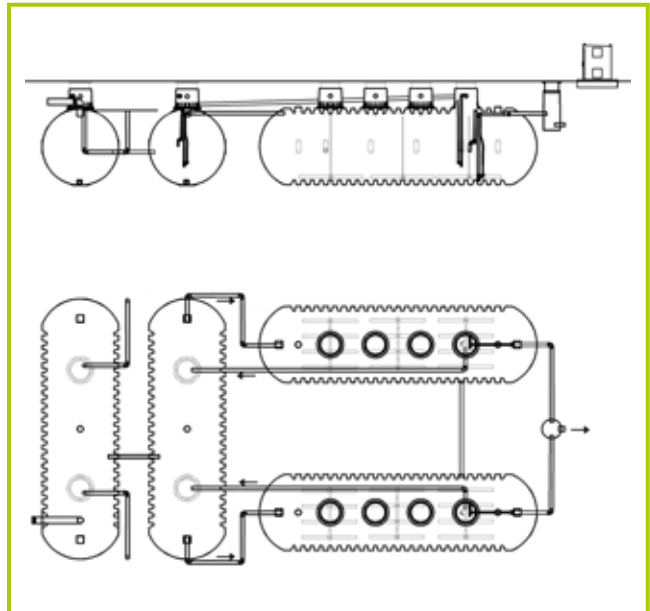



The former Formula 1 racing circuit Dijon Prenois is still a frequently visited racing circuit on which the MOTO GP Legend takes place every year. Up to 40,000 visitors arrive at this event. KLARO's engineers worked out a solution for intercepting the additional water and then reducing it intermittently over a short period of time. One more buffer tank was added, making the plant smaller overall. Thus, it runs equally smoothly on a day with less incidence of visitors. Previously, a collection tank was used into which the entire wastewater flowed and had to be regularly emptied from it. This variant represents a high financial expenditure, therefore a more cost-efficient solution was selected. Pre-assembled, rectangular concrete tanks were equipped with KLARO technology for that.

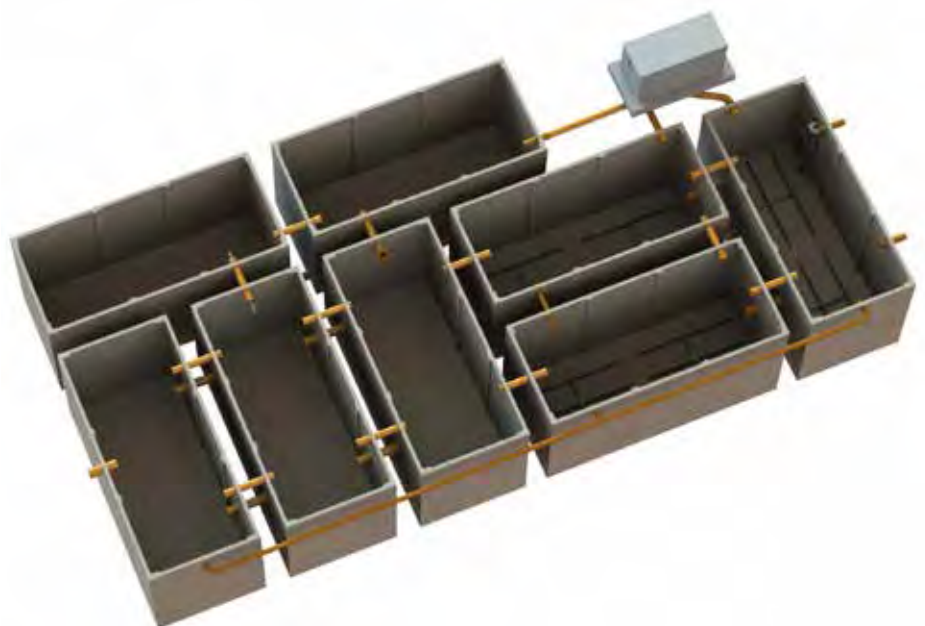

## Information

Tanks: Concrete

Compressor: KDT 3.140

Commissioning: 2016

## Discharge values

Parameters	Limit values [mg/l]	Measured values [mg/l]
BOD <sub>5</sub>	30	< 15
AFS	35	< 20

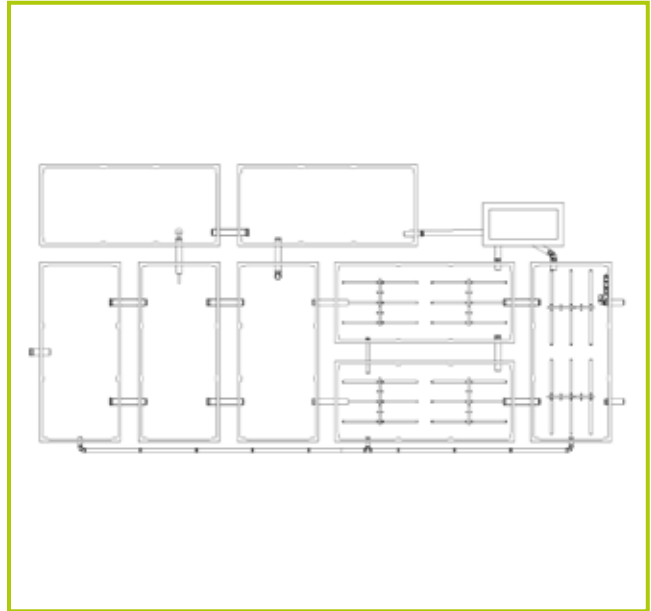



The Madlitzer Mühle is a big hotel at a distance of approx. 100 km from Berlin. The collection tank of the establishment had to be emptied multiple times in the week, causing the disposal costs to shoot up. Research done on conversion of existing tanks led them directly to KLARO.

The existing collection tank was converted into a sludge storage and buffer tank. Other SBR's were added to the plant. Overall, the plant has a 3-line arrangement and runs at 3 x 30 m<sup>3</sup>/d.

Today, the clarified wastewater is used for watering the adjacent paddocks. Directly next to it, there are groundwater tapping points as well, which have not yet yielded a negative finding to date.

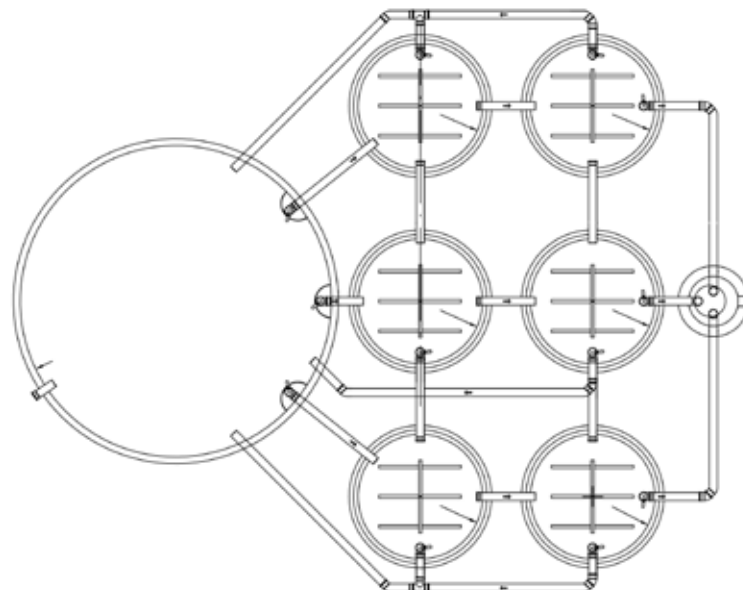

## Information

Tanks: Concrete

Compressor: 3 x KDT 3.80

Commissioning: 2010



## Discharge values

Parameters	Limit values [mg/l]	Measured values [mg/l]
BOD <sub>5</sub>	25	3.0
CSB	90	32
NH <sub>4</sub> -N	10	0.1
P <sub>total</sub>	1	0.4

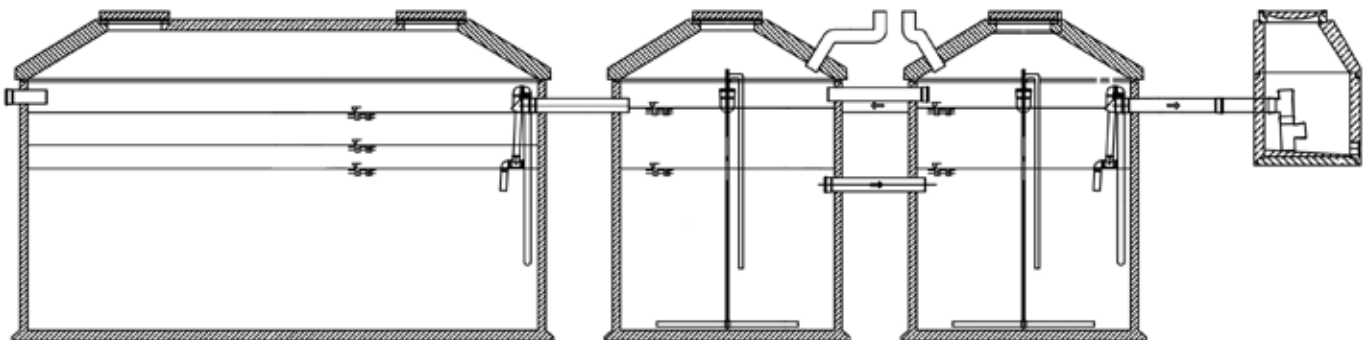





## Information

Tanks: Concrete

Compressor: 2 x KDT 3.140

Commissioning: 2016

The Parco Natura Viva wildlife park is a zoo in the vicinity of Lake Garda. The park has a number activities to offer. Visitors can drive through the zoo by car, or explore areas of the zoo on foot.

This plant was installed in pre-assembled, rectangular concrete tanks. It is arranged in two lines and each line runs at a capacity of 46,95 m<sup>3</sup>/d. If required, one line can be deactivated in winter, when off-season starts. In high season, the second line can be injected with sludge from the other plants, which is a significant advantage of multiple line systems. Thus, a good biological degradation can be expected from the very first day of high season.

## Discharge values

Parameters	Limit values [mg/l]	Measured values [mg/l]
BOD <sub>5</sub>	40	< 10
CSB	160	< 70
AFS	80	< 20
P <sub>total</sub>	10	< 2

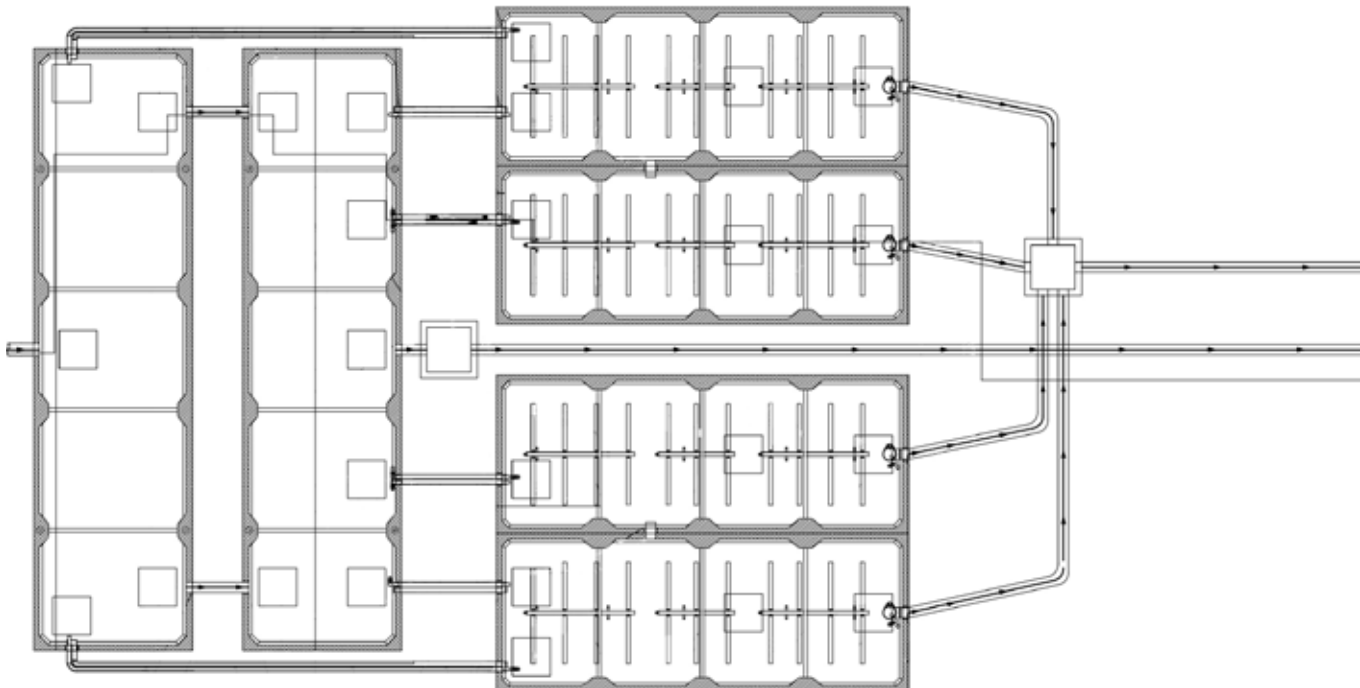



A KLARO 150 m<sup>3</sup>/d system has been operational for the largest Norwegian shipyard Aker Kværner in Stord. The world's largest oil rigs, among other things, were constructed and equipped here. The plant situated directly on the banks of the fjord clarifies the entire waste from the office, canteen and workers' flats.

The tank was constructed in rectangular shape from in-situ concrete and projects roughly halfway above the ground. The biological stage is distributed over two tanks which can be run independent of each other.

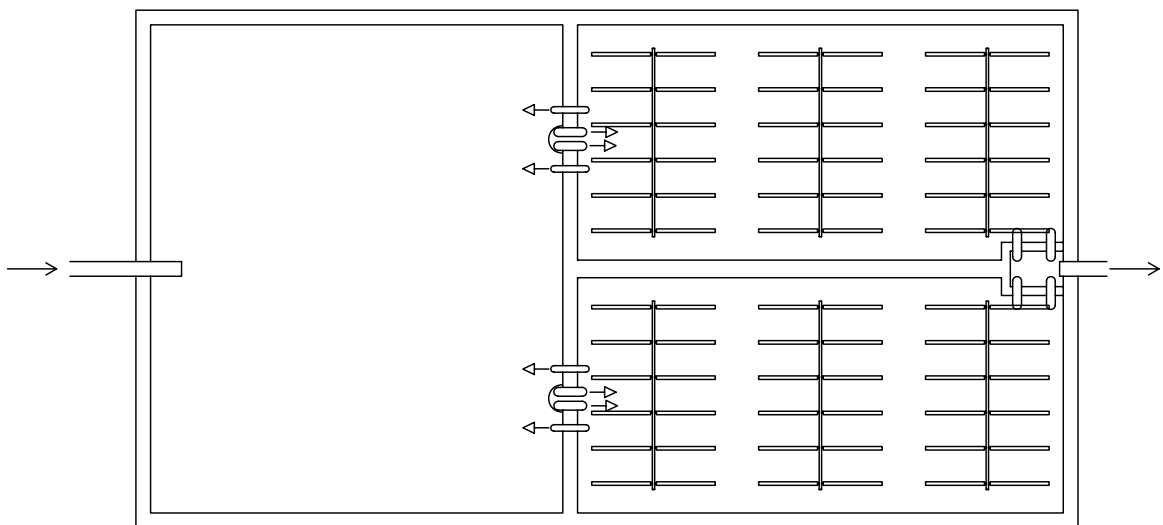

## Information

Tanks: Concrete

Compressor: 2 x KDT 3.140

Commissioning: 2010

## Discharge values

Parameters	Limit values [mg/l]	Measured values * [mg/l]
BOD <sub>5</sub>	20	12
AFS	30	19
P <sub>total</sub>	1	< 0.61

\* mean values over the period 2010 - 2017.



## Address



KLARO GmbH  
Spitzwegstraße 63  
95447 Bayreuth

## Website



Further information under  
[www.klaro.eu](http://www.klaro.eu)

## Information



Email: [info@klaro.eu](mailto:info@klaro.eu)  
Fax: +49(0)921 16279-100

## Technical hotline



Technical hotline  
**+49(0)921 16279-370**

